

This document is the property of Polyamp AB and shall not, without the permission of Polyamp AB, be allowed, copied, used for manufacturing or communicated to any other person or company.

Weight (kg/m ³)	Replaces dwg	Page 1(1)	Associated dwg No.	Units millimeters	Scale 1:1.5	Rev No 00
		PSC Series Wall mounting H15 connector		Tolerances/Tolerances ISIRI 7181 m Njammhet/Surf. list. RA 6,3	Designer roand Approved by Rev by	Date (y/m/d) 090120 Date (y/m/d) - Date (y/m/d) -
Dwg No.					PSC_01	

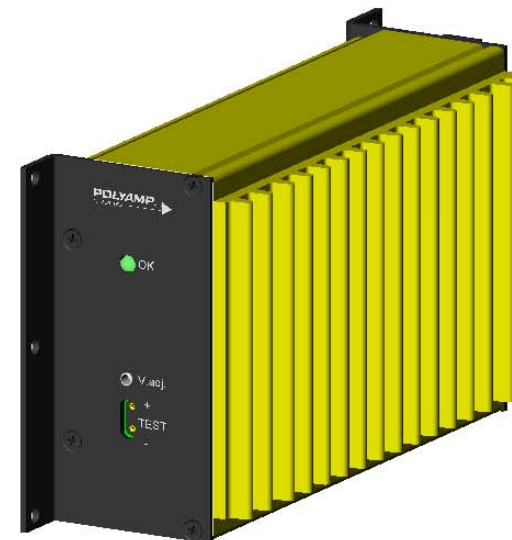
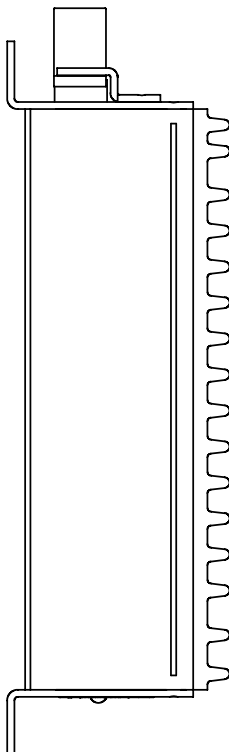
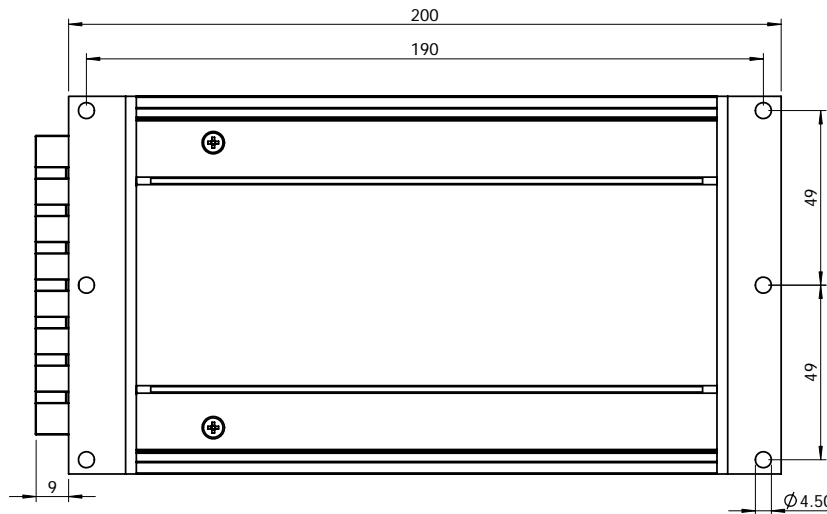
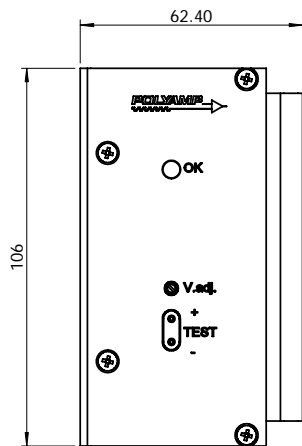

This document is the property of Polyamp AB and shall not, without the permission of Polyamp AB, be altered, copied, used for manufacturing or communicated to any other person or company.

Weight (kg/m ³)	Replaces dwg	Page 1(1)	Associated dwg No.	Units millimeters	Scale 1:1.5	Rev No. 00
		PSC Series Wall mounting H15 connector Addon cooler		Tolerances/Tolerances IS:ISO 2768-1 m Njammhet/Surf. text RA 6,3	Designer roand Approved by Rev by	Date (y/m/d) 090120 Date (y/m/d) Date (y/m/d)
					Dwg No. PSC_02	

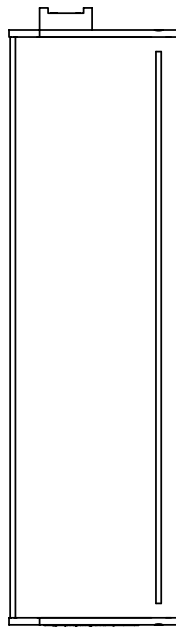
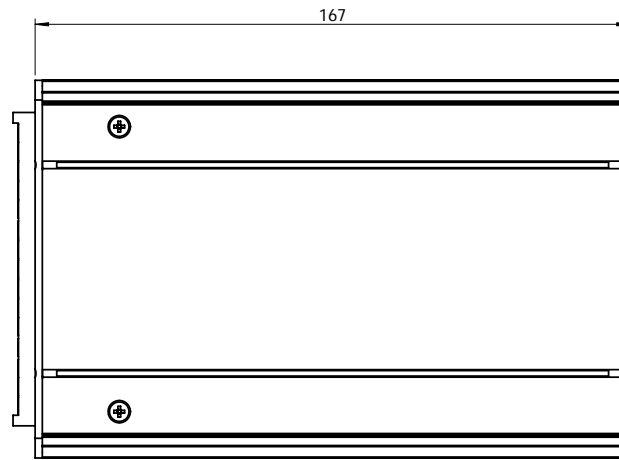
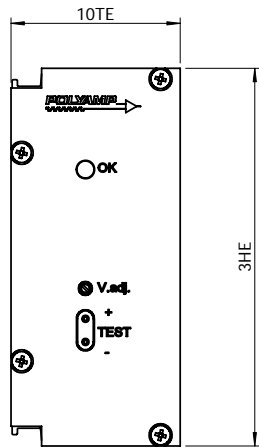

This document is the property of Polyamp AB and shall not, without the permission of Polyamp AB, be allowed, copied, used for manufacturing or communicated to any other person or company.

Weight (kg/m ³)	Replaces dwg	Page 1(1)	Associated dwg No.	Units millimeters	Scale 1:1.5	Rev No 00
		PSC Series Rack mounting 10TE H15 connector			Tolerances/Tolerances IS:ISO 2768:1 <i>m</i> Njammhet/Surf. list. RA 6,3	Designer roand Date (y/m/d) 090120 Approved by Date (y/m/d) - Rev by Date (y/m/d) -
					Dwg No. PSC_03	

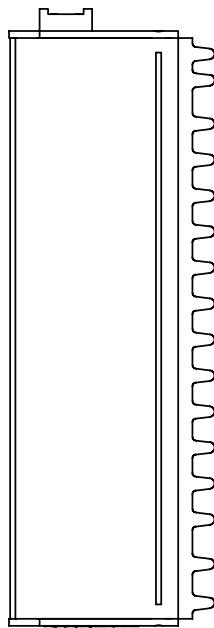
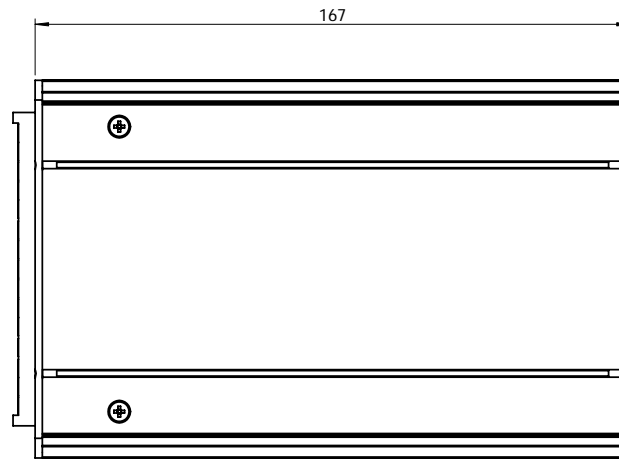
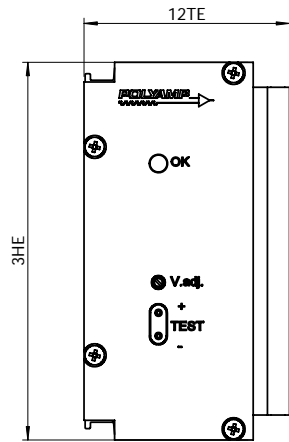

This document is the property of Polyamp AB and shall not, without the permission of Polyamp AB be allowed, copied, used for manufacturing or communicated to any other person or company.

Weight (kg/m ³)	Replaces drawing	Page 1(1)	Associated drawing No.	Units millimeters	Scale 1:1.5	Rev No. 00
		PSC Series Rack mounting 12TE H15 connector Addon cooler			Tolerances/Tolerances IS:ISO 2768:1 Designer round Date (y/m/d) 090120 Approved by m Date (y/m/d) - RA 6,3 Rev by - Date (y/m/d) - Dwg No.	PSC_04

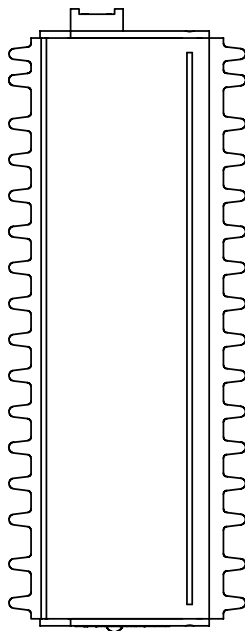
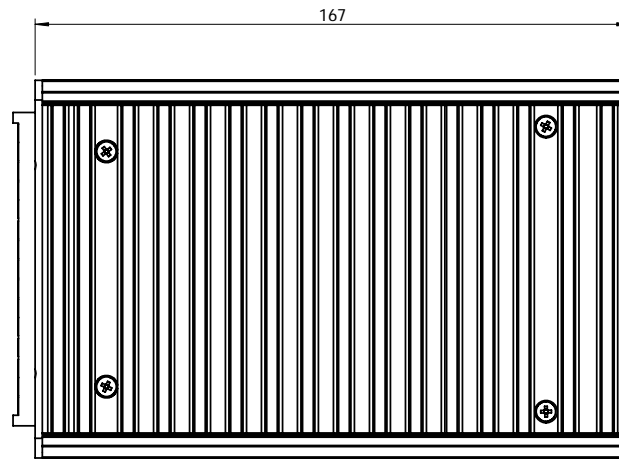
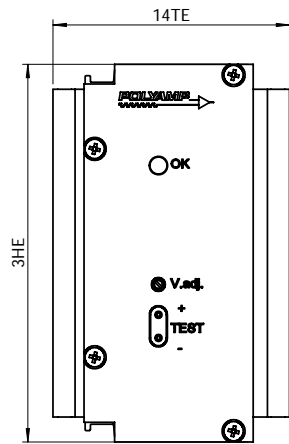

This document is the property of Polyamp AB and shall not, without the permission of Polyamp AB be allowed, copied, used for manufacturing or communicated to any other person or company.

Weight (kg/m ³)	Replaces (dwg)	Page 1(1)	Associated dwg No.	Units millimeters	Scale 1:1.5	Rev No. 00
		PSC Series Rack mounting 14TE H15 connector 2 addon cooler		Tolerances/Tolerances IS:ISO 2768-1 m Njmmhst/Surf. list RA 6,3	Designer roand Approved by Rev by	Date (y/m/d) 090120 Date (y/m/d) - Date (y/m/d) -
Dwg No.					PSC_05	

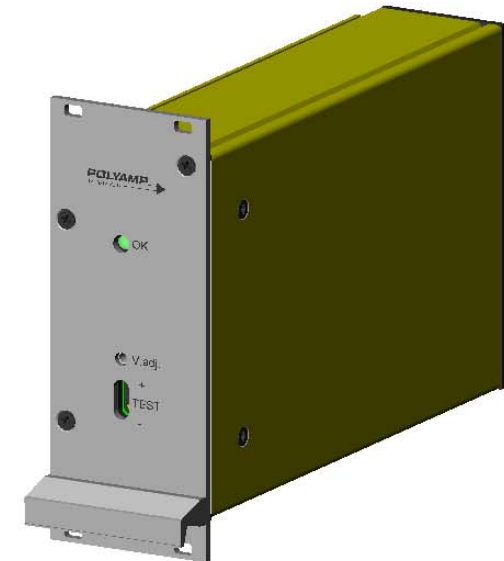
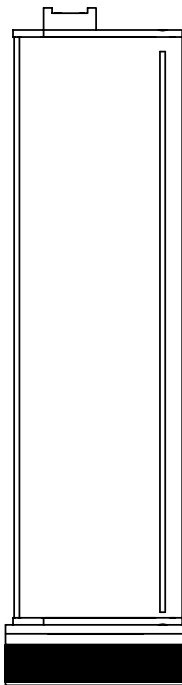
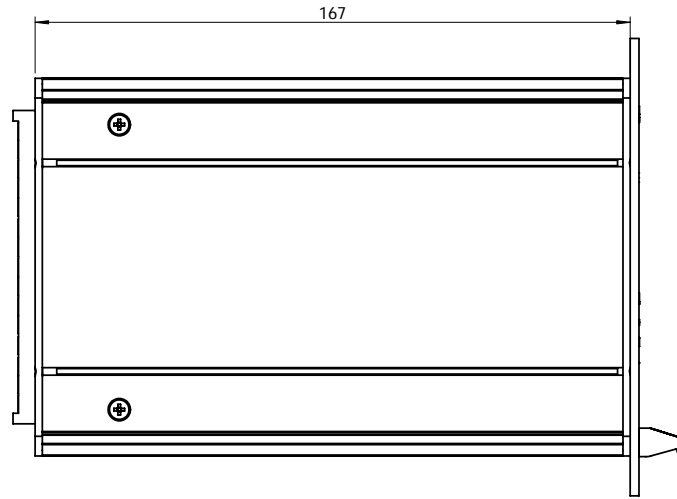
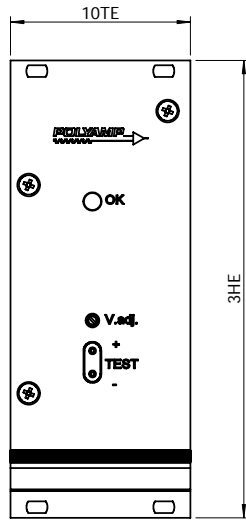

This document is the property of Polyamp AB and shall not, without the permission of Polyamp AB, be allowed, copied, used for manufacturing or communicated to any other person or company.

Weight (kg/m ³)	Replaces drawing	Page 1(1)	Associated drawing No.	Units millimeters	Scale 1:1.5	Rev No. 00
		PSC Series Rack mounting 10TE H15 connector			Tolerances/Tolerances IS:ISO 2768-1 m Njammhet/Surf. list. RA 6,3	Designer roand Approved by RA 6,3 Rev by Date (y/m/d) 090120
Dwg No. -					PSC_06	

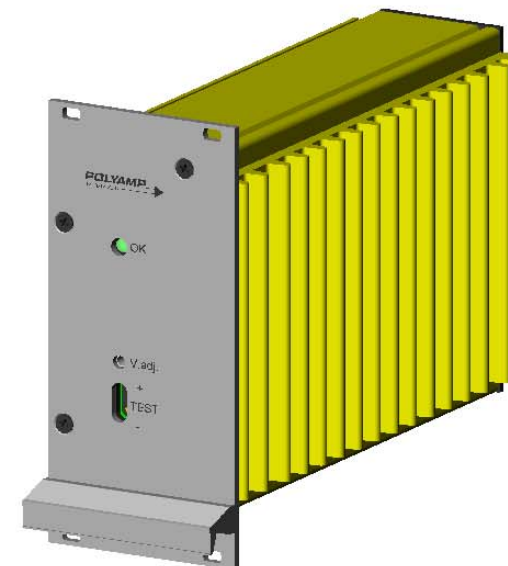
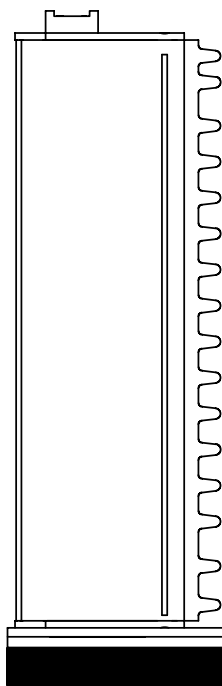
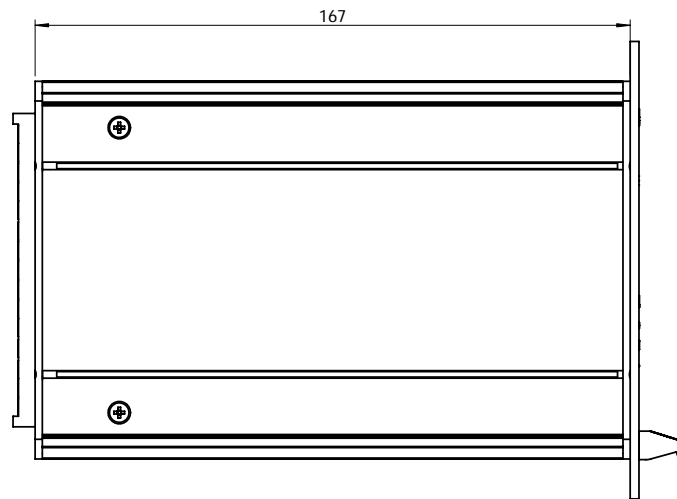
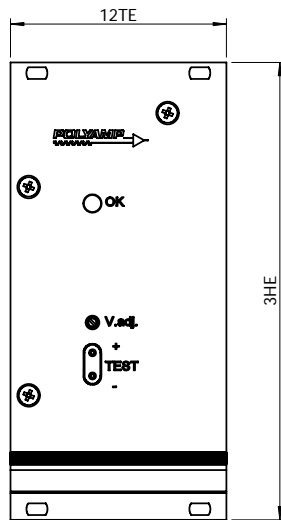

This document is the property of Polyamp AB and shall not, without the permission of Polyamp AB be allowed, copied, used for manufacturing or communicated to any other person or company.

Weight (kg/m ³)	Replaces drawing	Page 1(1)	Associated drawing No.	Units millimeters	Scale 1:1.5	Rev No. 00	
		PSC Series Rack mounting 12TE H15 connector Addon cooler			Tolerances/Tolerances IS:ISO 2768-1 m Njammhet/Surf. text. RA 6,3	Designer roand Approved by Rev by	Date (y/m/d) 090120 Date (y/m/d) - Date (y/m/d) -
Dwg No.					PSC_07		

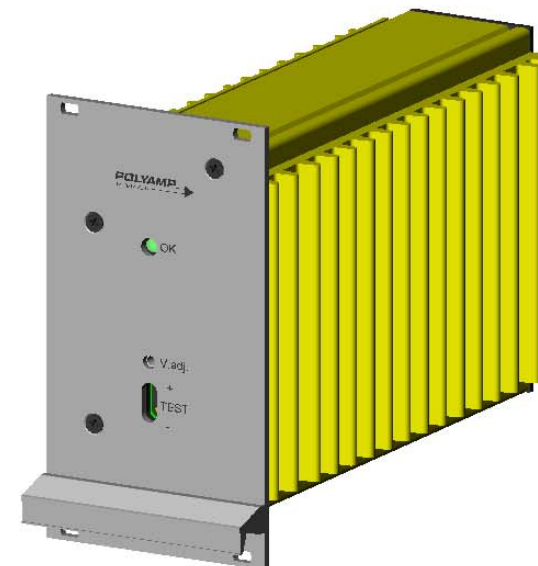
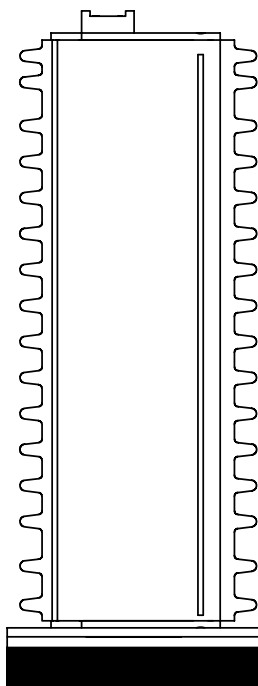
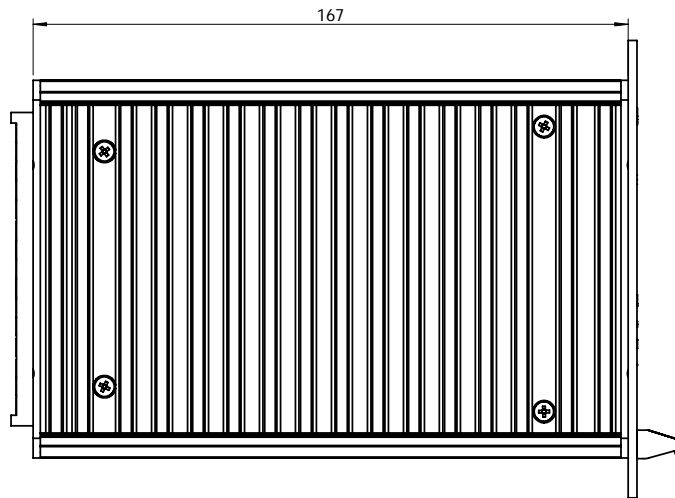
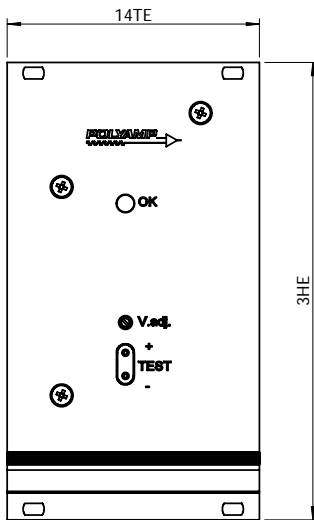

This document is the property of Polyamp AB and shall not, without the permission of Polyamp AB, be allowed, copied, used for manufacturing or communicated to any other person or company.

Weight (kg/m ³)	Replaces (dwg)	Page 1(1)	Associated dwg No.	Units millimeters	Scale 1:1.5	Rev No. 00
		PSC Series Rack mounting 14TE H15 connector 2 addon cooler		Tolerances/Tolerances IS:ISO 2768-1 m Njammhet/Surf. list. RA 6,3	Designer roand Approved by Rev by	Date (y/m/d) 090120 Date (y/m/d) - Date (y/m/d) -
Dwg No.					PSC_08	

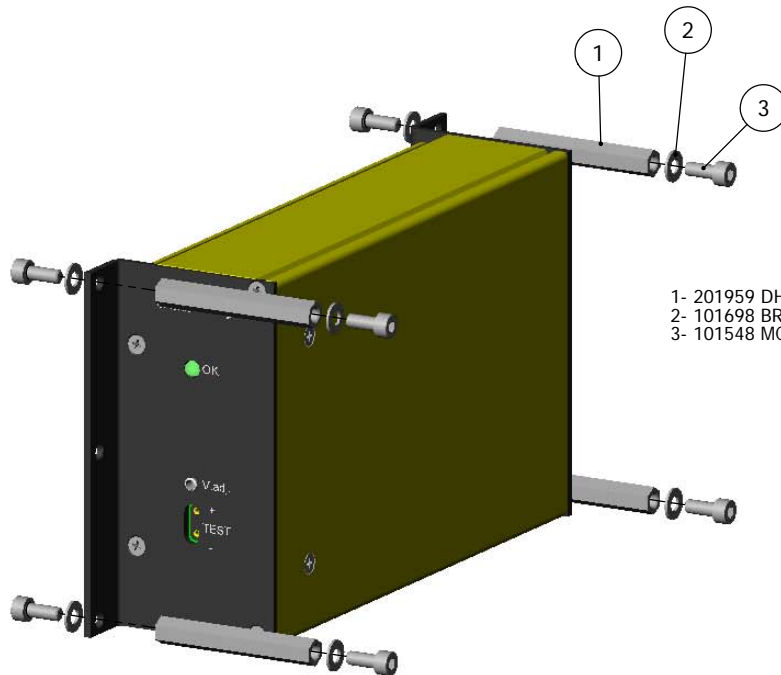
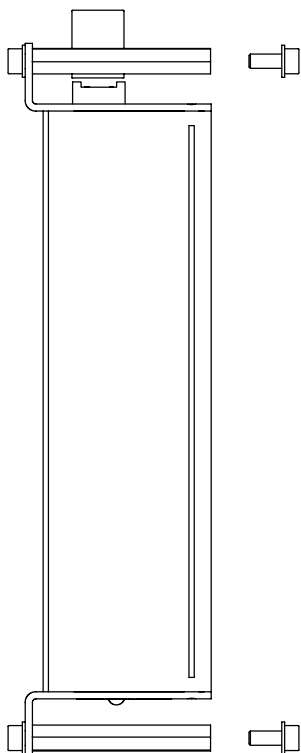
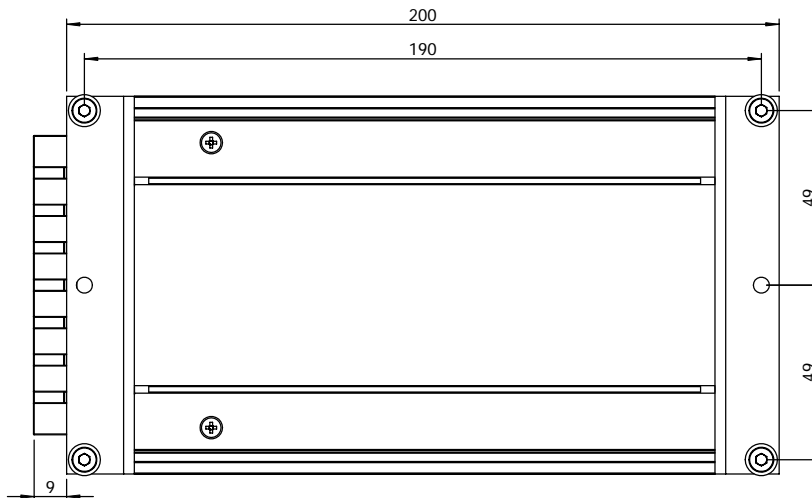
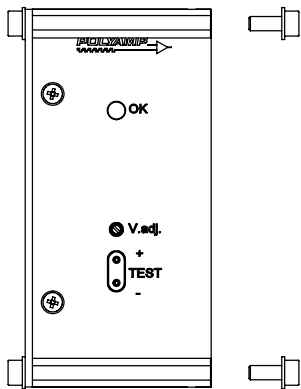

- 1- 201959 DHR M4X50 (4st)
- 2- 101698 BRB M4 A2 (8st)
- 3- 101548 MC6S M4X10 A2 (8st)

This document is the property of Polyamp AB and shall not, without the permission of Polyamp AB, be allowed, copied, used for manufacturing or communicated to any other person or company.

Weight (kg/m3)	Replaces dwg	Page 1(1)	Associated dwg No.	Units millimeters	Scale 1:1.5	Rev No 00	
	PSC Series			Tolerances/Intolerances ISIRI 7161.1	Designer roand	Date 090120	
	Wall mounting Spacer			RA 6,3	Approved by	Date	
	H15 connector				Rev by	Date	
						Dwg No.	PSC_09