

# HSE04801

**480W DC Power Supply, TS35mm DIN-Rail**

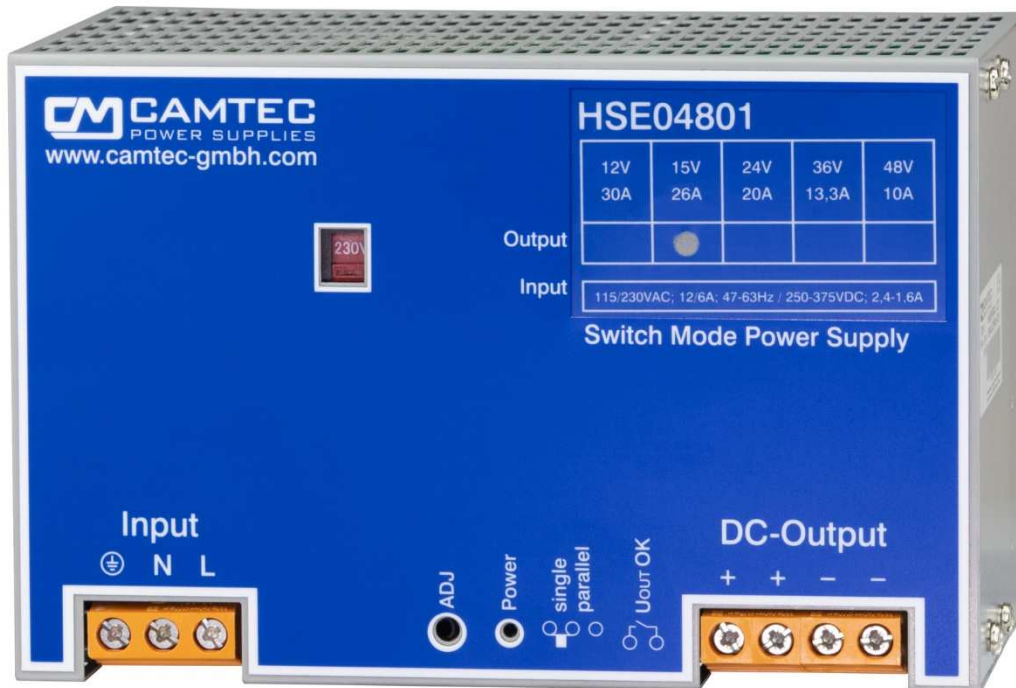

## Specification:

- Up to 91% efficiency
- Natural convection
- Hold-up time >50ms
- N+1 parallel operation
- Precision current voltage curve
- Precise dynamic response on load change
- Designed for long life under full stress
- Strong input filters
- High reliability, shock & vibration proof
- Over Voltage and continuous short circuit protection
- EMI/EMS EN61000-6-2,3, EN55032 class B
- EN61010-1, EN61010-2-201, EN62368-1

Models	Voltage	Current
HSE04801.012	12Vdc	30,0A
HSE04801.015	15Vdc	26,0A
HSE04801.024	24Vdc	20,0A
HSE04801.036	36Vdc	13,3A
HSE04801.048	48Vdc	10,0A





### Technical Concept

**The Camtec HSE models are industrial high-performance power supplies „Made in Germany“. These power supplies are designed as a working horse for complex loads, and for battery charging.**

For more than 20 years the Camtec Power Supplies manufactures high-end switch mode power supplies in Germany. A field breakdown of below 0,004% over a 10-year period under review approves our ambitious quality concept. Each manufactured Camtec product passes 100% tests for each detailed function and a full-load Burn-In test.

Although it is not required from the safety norms our production applies a routine safety test to each manufactured device, even if it is an extra low-voltage model. The components in the assembled device pass stress aging to achieve an even level and to prevent from delayed failures. Our internal product engineering guidelines provide a clear target: Camtec product reputation must say „mount and forget“. Quality is never a mere promise for our team.

The HSE power supplies provide low noise and ripple, and a precise setting at high load changes. With an efficiency up to 91% the devices are highly energy efficient.

Equipped with high-end capacitors of outstanding lifetime our power supplies guarantee a very long and reliable operation time. The circuit design of the HSE series allows cope playing with complex loads. The internal protection circuits protect the power supply and the connected system, even in exceptional situations. The HSE series is protected from high transients by strong filters with high energy efficiency. All inputs and outputs are electrically isolated. The design specifications call for the highest standards of safety and interference suppression.

The 480W and 720W models provide natural convection. The 1kW models use a forced air-cooling system with a fan. In selecting the fan, as with all our power supplies, in our opinion we use with the German manufacturer EBM Papst the highest quality and most reliable devices in the world market.

#### Design Conception

The HSE power supply series realizes high power in a space-saving housing. Latest generation electrical devices relate to the high reliability of all CAMTEC products. The CAMTEC philosophy is, to employ 125°C low ESR ultra long-life capacitors where expedient to achieve a superior lifetime of the product. The HSE power supply is made for high reliable and demanding industrial applications like galvanic systems, professional DC-drives, UPS-System, and high dynamic load.

#### Galvanic Isolation

The power supply is galvanic isolated between the input and the output. All features are connected to the DC power outputs.

#### Thermal shutdown

The HSE units are featured with a thermal overload shut down and auto recovery behaviour.

#### Over Voltage Protection

Ticker mode and auto recovery

#### Short Circuit Protection

A continuous short circuit does not cause damage to the power supply. The HSE units deliver constant current and zero output voltage. They recover automatically after the short circuit is released.

#### Open Circuit Protection

The HSE series is continuously open circuit protected. The device delivers a stable output voltage and no current. If a load is immediately connected to the device, the power supply stabilizes within 1ms. It does not overshoot the output voltage.

#### Power Up Ramp

The devices have a soft start ramp when powering up. The device does not either overshoot the voltage nor does the output flutter independent if a load is connected or not.

#### Current Voltage Chart, CV & CC mode

The HSE series provides a perfect current voltage chart. It has no fold back or other abnormalities. The output voltage can drop down to zero volts when the power supply is overloaded. The unit delivers a stable and constant current to the outputs.

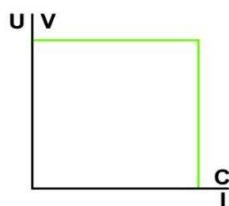



### Technical Table

AC Input Range	90-132Vac, 184-264Vac (115/230Vac input selector, factory setting is 230Vac)				
AC Input Frequency	47-63Hz				
DC Input Range	250Vdc-375Vdc (input selector set to 230Vac)				
AC Input Rated	115Vac<9.0A 230Vac<4.9A				
DC Input Rated	250Vdc<2.4A 375Vdc<1.6A (input selector set to 230Vac rated)				
DC Voltage Rated	12Vdc	15Vdc	24Vdc	36Vdc	48Vdc
DC Voltage Setting Range	11.4 - 14.4Vdc	14.2 - 18.0Vdc	22.8 - 28.8Vdc	34.2 - 43.2Vdc	45.6 - 52.8Vdc
DC Current Rated +60°C	30.0A	26.0A	20.0A	13.3A	10.0A
DC Current Rated +70°C	22.5A	19.5A	15.0A	10.0A	7.5A
Power Boost 60s +60°C	33.0A	28.6A	22.0A	14.6A	11.0A
Over Voltage Protection	18Vdc	22Vdc	35Vdc	51Vdc	59Vdc
Over Current Protection	34.5A	29.9A	23.0A	15.3A	11.5A
Ripple Peak 230Vac 20MHz	40mVpp	50mVpp	50mVpp	100mVpp	100mVpp
Load regulation 0-100%	< ±0.1%	< ±0.1%	< ±0.1%	< ±0.1%	< ±0.1%
Response Load Change	<1ms 10-100%, 100-10%				
Start-up Delay	Typ. 250ms				
Softstart	Typ. 100ms				
Base Load	None				
Efficiency 230Vac	91% typical				
Short Circuit Protection	Continuous				
Idling-proof	Yes				
Temperature Control	Yes, thermal shutdown with auto recovery (+70°C, metering distance 50mm)				
Hold Up Time	>50ms @ 230Vac				
Inrush Current	<81A (230Vac) cold start 25°C				
MCB (Circuit Breaker)	16A curve C @ 115Vac, 16A curve C @ 230Vac				
Cooling	Natural convection				
Ambient Operating Temp.	- 25°C...+70°C, derating 2,5%/°C >60°C				
Ambient Storage Temp.	- 40°C...+85°C				
Environment	Humidity 95% non-condensing @ 25°C, climate class. 3k3, pollution degree 2				
ROHS	2011/65/EU, (EU)2015/863				
REACH	EG No. 1907/2006				
EMI	EN55032 class B, EN61000-6-3				
EMS	EN61000-6-2				
Safety	EN61010-1, EN61010-2-201, EN62368-1, EN60950-1, EN60204-1				
Protection Class I	PE connection required				
Altitude Operations	2000m (6562 ft.) above sea level				
Creepage Distance	>8mm				
Input to Output Isolation	3000Vac				
Input to Case Isolation	2500Vac				
Output to Case Isolation	500Vdc				
MTBF (IEC61709)	500000h (Meantime Between Failures: statistic time between failures after repairs)				
MTTF (IEC61709)	160124h (Meantime To Failure: statistic time to ever fails)				
Dimensions (HxWxD)	130x200x115mm				
Weight	2,8kg / 6,2lbs				
AC Terminals	Input Screw Terminal 3x AWG22 – AWG6 / 0,5 – 16mm <sup>2</sup> (L,N,PE)				
DC Terminals	Output Screw Terminal 4x AWG22 – AWG6 / 0,5 – 16mm <sup>2</sup> (+ + / - - )				

## Manual und Technical Details

### Temperature Derating

The maximum ambient temperature during operation is + 70°C. If the over temperature protection is activated, the power supply is switched off.

The measuring point is 50mm outside the power supply. The power supply unit starts automatically when it has cooled down.

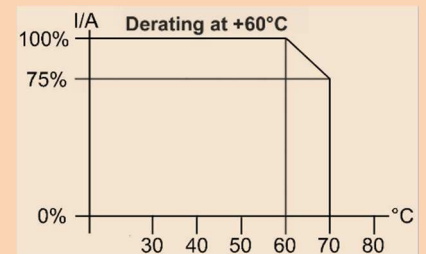

### Baseplate Cooling & Temperature Management

The temperature management of the HSE series provides a direct dissipation of the main energy losses. The internal coolers of the output diodes and the power FETs connect to the back-plate cooler. It is possible to dissipate about 40 – 50% of the energy losses out of a system to a plane and heat conductive surface. For further information please consult our technical support.

### Parallel Operation & N+1 Decoupling

To increase the overall power of the power supply, two or more devices of the same model with the same output voltage may be operated in parallel. We recommend using a busbar for the DC power connector. Make sure that the cable lengths and cable cross-sections of all power supplies to the busbar or to the star point are identical. Allow proper connection for low contact resistance. The output voltage of each involved power supply units must be adjusted 100% equal. Set the indicated switcher at the bottom of the power supply from “single” (factory pre-set) to “parallel” operation. The C/V characteristic line will slightly ream. The power-output distribution between the involved units will be more accurate.

The HSE models have no internal O-ring diode, to operate the devices N+1 redundant. Such, we recommend using our RED00202 DIN-rail redundant decoupling modules.

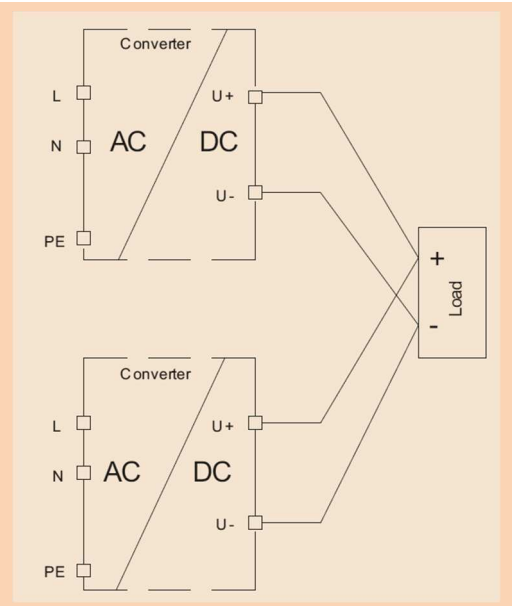

### C/V Current Voltage Behaviour

The HSE series provides a perfect current voltage chart. It has no fold back or other abnormalities. The output voltage can drop down to zero volts when the power supply is overloaded. The unit delivers a stable and constant current to the outputs.

When the output voltage is set to the maximum demanded value and the current limit circuit acts, the output voltage drops linear down to zero and the unit delivers constant current.

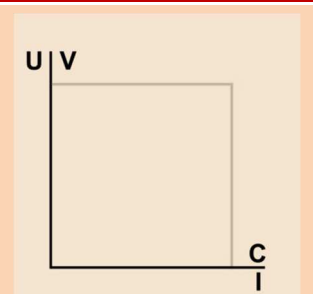

### Coating Option

We offer the HSE-series with optional coating. It is to be used in e.g., dusty, dirty, high humidity, or in awaiting quick temperature changes. Short circuit and corrosion at print board lines and at solder points can be prevented. The coat itself is a transparent acrylic resin. Peters SL 1306 N-FLZ (transparent) IEC60216-1 2001, IPC-CC-830B, UL listed as permanent coating File No.: E80315 , UL94V-0

### Technical Data Table – Power OK Connection & Voltage Setting

Feature	Technology	Details and Connections	Section	Isolation
Potentiometer Voltage	1 turn	High precision	U adj	3000Vac to input & output
Power Good Relay	“b” contact	AWG24 – AWG14 / 0,25 – 2,5mm <sup>2</sup>	DC-ok	3000Vac to input & 500Vdc to output

### DC Voltage setting range

Rated DC Voltage	12Vdc	15Vdc	24Vdc	36Vdc	48Vdc
Rated DC Current	30.0A	26.0A	20.0A	13.3A	10.0A
DC Voltage Setting Range	11.4-14.4Vdc	14.2-18.0Vdc	22.8-28.8Vdc	34.2-43.2Vdc	45.6-52.8Vdc

The DC voltage can be adjusted with a precision 1 turn potentiometer with low temperature fading. The factory setting is to the rated voltage from the table above.

### DC-OK Relay

The DC ok relay indicates if the output voltage is low and if the AC voltage is low. The contact is galvanic insulated to the AC input and the DC output connections. The isolation to the AC input is 3000Vac with a forced isolation and covers the overall adjustment range of the HSE models. If the DC voltage is ok the relay is closed, if the power supply unit is in false operation the relay is open. Considering the lower and the upper margin of the AC voltage detection it is to say that the HSE series starts at 85Vac/150Vac depending on the AC input selector. The unit starts with 200Vdc when a DC voltage applies to the input. Make sure to set the AC input selector to 230Vac (factory setting) for DC input supply. DC-Fail hysteresis: drop-out 20%  $V_{nominal}$  / pull-in 60%  $V_{nominal}$ . Contact Rating 30Vdc/1A, 60Vdc/0.3A, 30Vac/0.5A

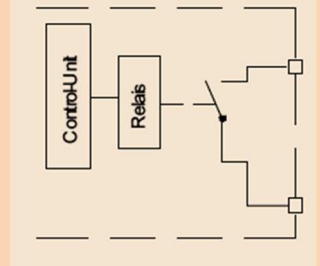

### DC OK Indication

Power Supply Status	Normal	Over Temperature	AC Low [V]	DC Low [V]
Relay Operation Status	Closed	Open	Open	Open

### Electrical Safety (Factory-Test / Field-Test Owner)

	T	A	B	C	D
Type Test	60s	2500Vac	3000Vac	500Vdc	500Vdc
Factory Test	5s	2000Vac	2000Vac	500Vdc	500Vdc
Field Test	2s	2000Vac	2000Vac	500Vdc	500Vdc
Cut-off current setting	>15mA	>15mA	>1mA	>1mA	>1mA

Type and factory test are the manufacturer. While repeating damage can happen to the power supply unit. For the field test (owner) follow the below instruction:

- Use suitable test equipment, raising the voltage slowly.
- Short circuit L1 and N, and all the DC output terminals.
- Use only test voltages of 50/60Hz. The outputs are unearthed and therefore they have no resistance to GND/PE.
- If the residual voltage is  $\geq 60Vdc$ , observe the safety standards. Use only specially insulated screwdriver to trim the Ua/Ia.

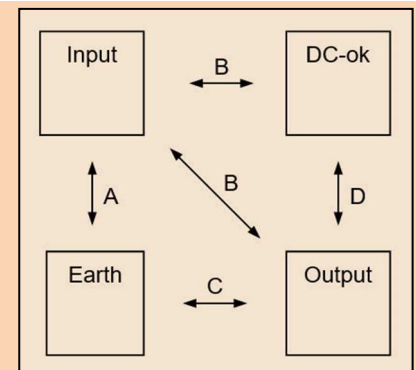

## Mechanics

### ST-HD Baseplate Cooling & Temperature Management

The temperature management of the HSE series provides a direct dissipation of the main energy losses. The internal coolers of the output diodes and the power FETs connect to the back-plate cooler. It is possible to dissipate about 40 – 50% of the energy losses out of a system while using the Baseplate cooling bundle 2201002001 to hard mount the unit to a plane and heat conductive surface.

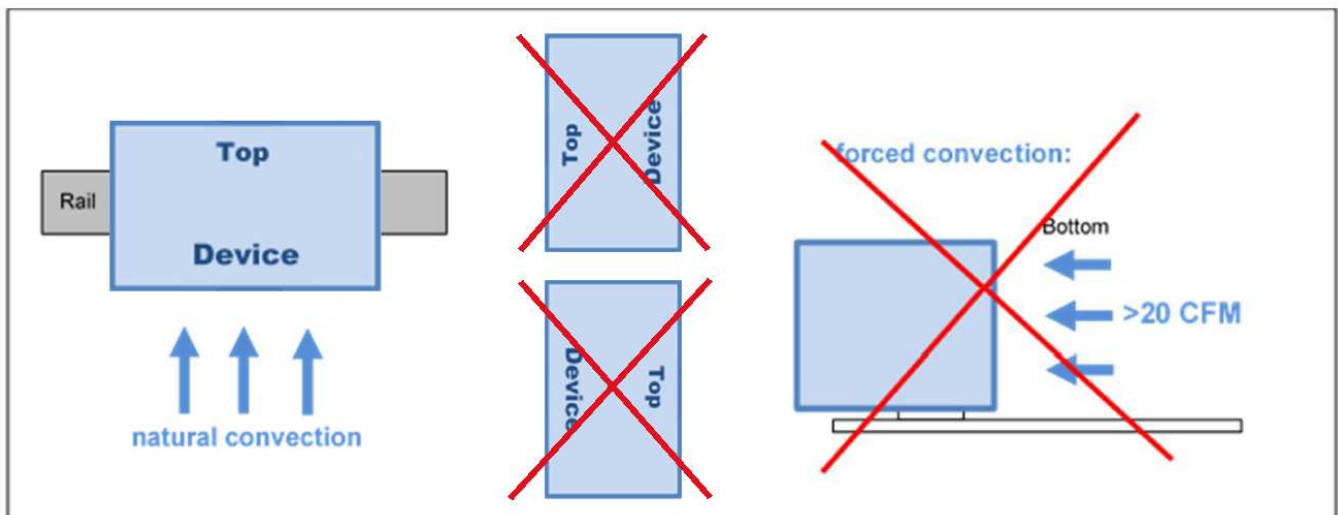
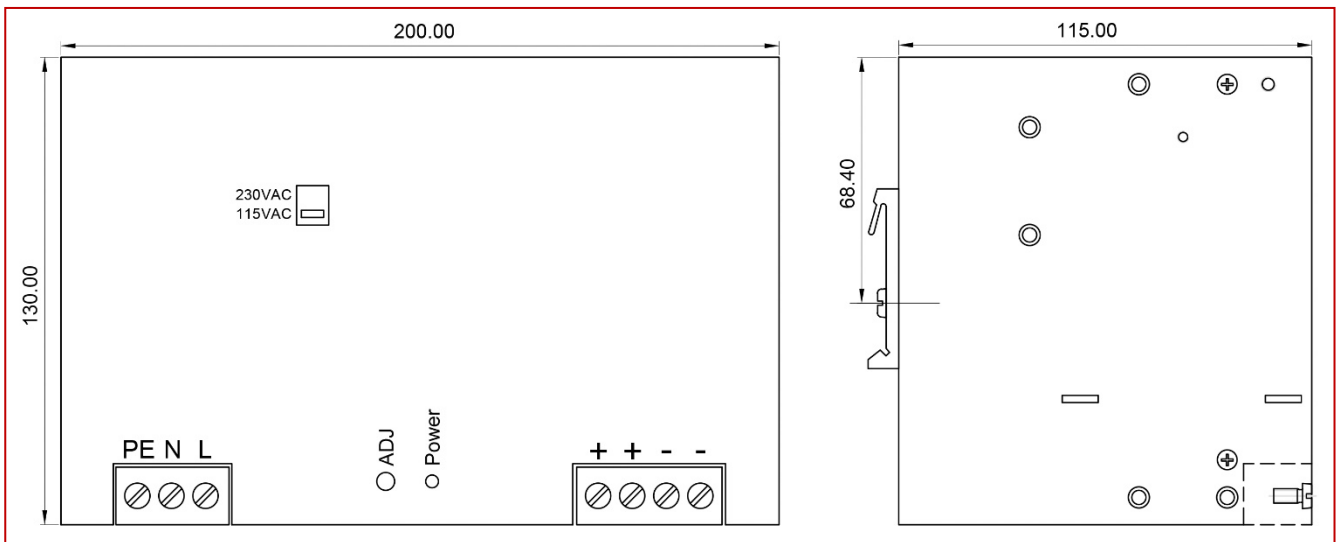

Mounting Instruction: recommended airflow space below and above is 50mm (2 Inch)



### Mechanics & Installation Instruction of the HSE

Stable metal/aluminium housing IP20. To allow adequate convection, a free air space of 50mm (top/bottom) and 10mm (sidewalls) is required; and for active devices 15mm space from the sidewalls. For proper air convection it is necessary to install the HSE.

One can use the DIN-Rail installation (equipped standard) with our patented 35mm DIN-Rail bracket according to EN60715. It is easy to mount/dismount while snapping it onto the 35mm DIN-Rail - no tools necessary.

**It is not allowed to install the HSE in other mounting direction then below drawings.**

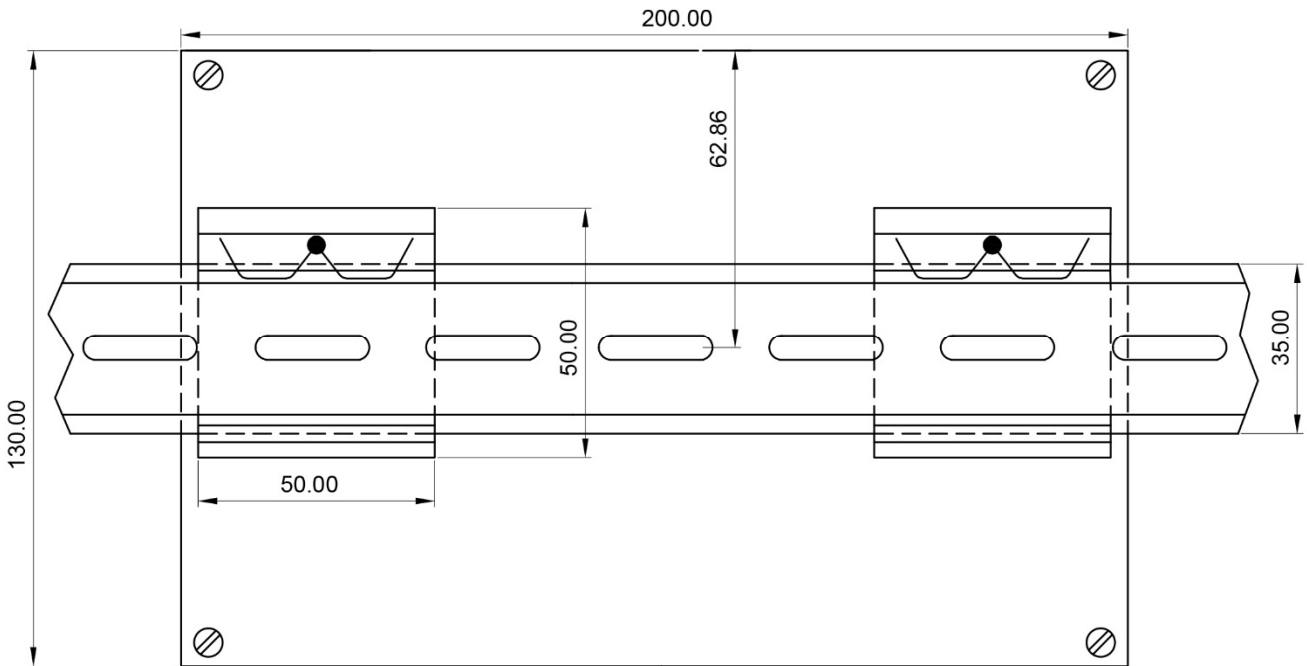

### Back Plate Option / DIN-Rail Standard

(The HSE is always delivered for DIN-rail mount, the back-plate is an optional part that shall be mounted from the customer. The threads from the DIN-rail mounting brackets shall be used. All screws are included into the Back-Plate Kit.)

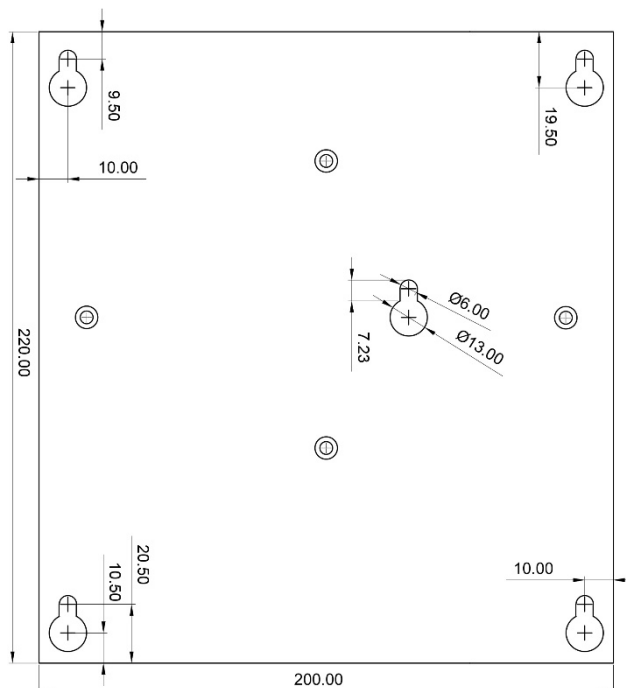

## Connections

### Clamping Yoke Connector Specifications

	Input / Output connections	Optional Power OK connection plug
Tightening torque min. – max.	1,2 – 2,2Nm (blade 1,0x5,5 DIN5264 )	0,4 – 0,5Nm (blade 0,6x3,5 PH1 PZ1)
Touch-safe protection acc. to DIN VDE 0470	IP20 plugged/ IP10 unplugged	Not applicable
Clamping range, min. – max.	0,5 – 16mm <sup>2</sup> / AWG26 – AWG6	0,2 – 4,0mm <sup>2</sup> / AWG26 – AWG12
Solid, H05(07) V-U min. – max.	0,5 – 16mm <sup>2</sup>	0,2 – 4,0mm <sup>2</sup>
Stranded, H05(07) V-U min. – max.	6 – 16mm <sup>2</sup>	Not applicable
Flexible, H05(07) V-U min. – max.	0,5 – 16mm <sup>2</sup>	0,2 – 4,0mm <sup>2</sup>
w. plastic collar ferrule, DIN 46228 pt 4 min. – max.	2,5 – 10mm <sup>2</sup>	0,2 – 2,5mm <sup>2</sup>
w. wire end ferrule, DIN 46228 pt 1, min. – max.	2,5 – 10mm <sup>2</sup>	0,2 – 4,0mm <sup>2</sup>
Plug gauge in accordance with EN 60999 a x b; ø	5,4 x 5,1mm; 5,3mm	2,8 x 2,4mm; 2,5mm
Pitch (P)	10,16mm	5,08mm

### Wire Stripping Length (fine wired)

Nominal Cross Section	Wire End Ferrule	Stripping Length	Wire End Ferrule	Stripping Length
0,25mm <sup>2</sup>	H0,25/5	5mm	H0,25/10 HBL	8mm
0,5mm <sup>2</sup>	H0,5/6	6mm	H0,5/12 OR	8mm
1,0mm <sup>2</sup>	H1,0/6	6mm	H1,0/12 GE	8mm
2,5mm <sup>2</sup>	H2,5/12	12mm	H2,5/19D BL	14mm
4,0mm <sup>2</sup>	H4,0/12	12mm	H4,0/20 GDR	14mm
6,0mm <sup>2</sup>	H6,0/20	12mm	H6,0/20 SW	14mm
10,0mm <sup>2</sup>	H10,0/12	12mm	H10,0/22 EB	15mm

The length of ferrules is to be chosen depending on the rated voltage. The outside diameter of the plastic collar should not be larger than the pitch (P)

## Ordering Information

### Ordering Codes

Product Code	Information	Article Number
HSE04801.012(R2)	12V	3041029014CA
HSE04801.015(R2)	15V	3041029015CA
HSE04801.024(R2)	24V	3041029017CA
HSE04801.036(R2)	36V	3041029019CA
HSE04801.048(R2)	48V	3041029018CA
Back Plate Kit	Hart mount plate kit including screws	2201002001CA
Optional Power OK Connector	Optional, 2poles Clamping Yoke Connector 180° cabling (10pcs per pack)	3520037





**Safety regulations: Please read these instructions completely before using the equipment. Keep these instructions on to hand. The device may only be operated by trained specialist staff.**

**Installation:**

- 1) The device is designed for devices and systems that meet the standard requirements for hazardous voltages, power, and fire prevention.
- 2.) Installation and service only by trained specialists. The AC power must be switched off. The work is to be labelled; accidental reconnection of the system must be prevented.
- 3.) Opening the device, its modification, loosening bolts, or operation outside the specified herein specification or in an unsuitable environment, has the immediate loss of warranty to follow. We disclaim any responsibility for any resulting damage to persons or things.
- 4.) Note: The device must not be operated without an upstream circuit breaker (CB). We recommend the use of C-Type 16A for 230Vac and for 115Vac. It is prohibited to use the unit without PE. It may be necessary upstream device has a power switch.

**Warning:**

**Non-compliance these warnings can result in fire and serious injury or death.**

1. Never operate device without PE connection.
2. Before connecting the device to the AC network, make wires free of voltage and ensure that it cannot accidentally switch on.
3. Allow neat and professional cabling.
4. Never open nor try to repair the unit. Inside are dangerous voltages that can cause electrical shock hazard.
5. Avoid metal pieces or other conductive material to fall into the item
6. Do not operate the device in damp or wet conditions
7. Do not operate the unit under EX-conditions



All parameters after 15 minutes of continuous operation at full load / 25°C / 230Vac 50/60Hz, unless otherwise indicated.