



HSW00751

75W DC Power Supply, TS35mm DIN-Rail



Specification:

- Up to 90% efficiency
- Natural convection
- Hold-up time >70ms
- N+1 parallel operation
- Metal housing
- Open Circuit Proof
- Designed for long life under full stress
- Strong input filters
- High reliability, shock & vibration proof
- Over Voltage and continuous short circuit protection
- EMI/EMS EN61000-6-2,3, EN55032 class B
- EN61010-1, EN61010-2-201, EN62368-1

Models	Voltage	Current
HSW00751.005	5Vdc	7.5A
HSW00751.009	9Vdc	7.5A
HSW00751.012	12Vdc	6.0A
HSW00751.015	15Vdc	5.0A
HSW00751.024	24Vdc	3.2A





Technical Concept

The Camtec HSW models are industrial power supplies „Made in Germany“. These power supplies are designed as a working horse for applications where a long lifetime is in the focus.

For more than 25 years the Camtec Power Supplies manufactures high-end switch mode power supplies in Germany. A field breakdown of below 0,004% over a 10-year period under review approves our ambitious quality concept. Each manufactured Camtec product passes 100% tests for each detailed function and a full-load Burn-In test.

Although it is not required from the safety norms our production applies a routine safety test to each manufactured device, even if it is an extra low-voltage model. The components in the assembled device pass stress aging to achieve an even level and to prevent from delayed failures. Our internal product engineering guidelines provide a clear target: Camtec product reputation must say „mount and forget“. Quality is never a mere promise for our team.

The HSW power supplies provide low noise and ripple, and a precise setting at high load changes. With an efficiency up to 90% the devices are highly energy efficient.

Equipped with high-end capacitors of outstanding lifetime our power supplies guarantee a very long and reliable operation time. The circuit design of the HSW series allows cope playing with complex loads. The internal protection circuits protect the power supply and the connected system, even in exceptional situations. The HSW series is protected from high transients by strong filters with high energy efficiency. All inputs and outputs are electrically isolated. The design specifications call for the highest standards of safety and interference suppression.

Design Conception

The HSW power supply series realizes high power in a space-saving housing. Latest generation electrical devices relate to the high reliability of all CAMTEC products. The CAMTEC philosophy is, to employ 125°C low ESR ultra long-life capacitors where expedient to achieve a superior lifetime of the product.

Galvanic Isolation

The power supply is galvanic isolated between the input and the output. All features are connected to the DC power outputs.

Over Voltage Protection

Ticker mode and auto recovery

Short Circuit Protection

A continuous short circuit does not cause damage to the power supply. The HSW units go into ticker operation. They recover automatically after the short circuit is released.

Open Circuit Protection

The HSW series is continuously open circuit protected. If a load is immediately connected to the device, the power supply stabilizes within 1ms. It does not overshoot the output voltage.

Power Up Ramp

The devices have a soft start ramp when powering up. The device does not either overshoot the voltage nor does the output flutter independent if a load is connected or not.

Sense function

The HSW00751.005 (5V/7.5A) model is featured with a sense connection. The sense automatically compensates voltage drop on the load lines up to 0,2V.



Technical Table

AC Input Range	90-264Vac				
AC Input Frequency	47-63Hz				
DC Input Range	110Vdc-375Vdc				
AC Input Rated	115Vac<1.5A 230Vac<0.9A				
DC Input Rated	110Vdc<0.85A 375Vdc<0.25A				
DC Voltage Rated	5Vdc	9Vdc	12Vdc	15Vdc	24Vdc
DC Voltage Setting Range	4.9 - 5.5Vdc	8.6 - 9.9Vdc	11.4 - 13.2Vdc	14.3 - 16.5Vdc	24.0 – 28.0Vdc
DC Current Rated +60°C	7.5A	7.5A	6.0A	5.0A	3.2A
DC Current Rated +70°C	5.6A	5.6A	4.5A	3.7A	2.4A
Power Boost 60s +60°C	8.3A	8.3A	6.6A	5.5A	3.5A
Ripple Noise 230Vac 20MHz	15mVpp	20mVpp	20mVpp	20mVpp	50mVpp
Over Voltage Protection	7,5Vdc	13Vdc	18Vdc	22Vdc	35Vdc
Over Current Protection	9.0A	9.0A	7.2A	6.0A	3.8A
Load Regulation 0-100%	< ±0.2%	< ±0.7%	< ±0.5%	< ±0.3%	< ±0.2%
Response Load Change	<1ms 10-100%, 100-10%				
Start-up Delay	Typ. 0.4s @ 230Vac, 1.0s @ 115Vac				
Softstart	Typ. 100ms				
Base Load	None				
Efficiency 230Vac	90% typical				
Short Circuit Protection	Continuous				
Idling-proof	Yes				
Hold Up Time	>70ms @ 230Vac				
Inrush Current	<32Apeak 230Vac cold start 25°C				
MCB (Circuit Breaker)	8A curve B				
Cooling	Natural convection				
Ambient Operating Temp.	- 25°C...+70°C, derating 2,5%/°C >60°C				
Ambient Storage Temp.	- 40°C...+85°C				
Environment	Humidity 95% non-condensing @ 25°C, climate class. 3k3, pollution degree 2				
ROHS	2011/65/EU, (EU)2015/863				
REACH	EG No. 1907/2006				
EMI	EN55032 class B, EN61000-6-3, EN61000-3-2 class A				
EMS	EN61000-6-2				
Safety	EN61010-1, EN61010-2-201, EN62368-1, EN60950-1, EN60204-1				
Protection Class I	PE connection required				
Creepage Distance	>8mm				
Input to Output Isolation	3000Vac				
Input to Case Isolation	2500Vac				
Output to Case Isolation	500Vdc				
MTBF (IEC61709)	500000h (Meantime Between Failures: statistic time between failures after repairs)				
MTTF (IEC61709)	140182h (Meantime To Failure: statistic time to ever fails)				
Dimensions (HxWxD)	102x50x93,1mm				
Weight	0,44kg / 0,97lbs				
Input & Output Terminals	Spring-type terminal solid max. 0,25...2,5mm ² 24...14AWG according with IEC/EN60664-1, IEC/EN61984, Use copper conductors only. Wire stripping length 7mm. Tightening torque per terminal block is 0.4 - 0.5 Nm / 2.9 – 3.6 lbf-in				

Manual und Technical Details

Temperature Derating

The maximum ambient temperature during operation is + 70°C.

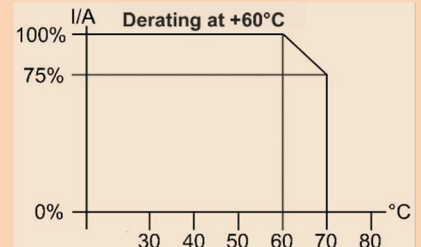
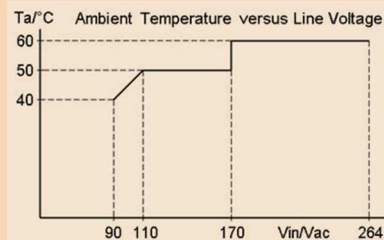

Baseplate Cooling & Temperature Management

The temperature management of the HSW series provides a direct dissipation of the main energy losses. The internal coolers of the output diodes and the power FETs connect to the back-plate cooler. It is possible to dissipate about 40 – 50% of the energy losses out of a system to a plane and heat conductive surface. For further information please consult our technical support.

Parallel Operation & N+1 Decoupling

To increase the overall power of the power supply, two or more devices of the same model with the same output voltage may be operated in parallel. We recommend using a busbar for the DC power connector. Make sure that the cable lengths and cable cross-sections of all power supplies to the busbar or to the star point are identical. Allow proper connection for low contact resistance. If you want to use the sensing function, connect it also to the star point or busbar. To avoid measurement errors, select the line length from the neutral point or from the busbar to the load as short as possible and use the maximum possible conductor cross-section.

The HSW models have no internal O-ring diode, to operate the devices N+1 redundant. Such, we recommend using our RED00202 DIN-rail redundant decoupling modules.

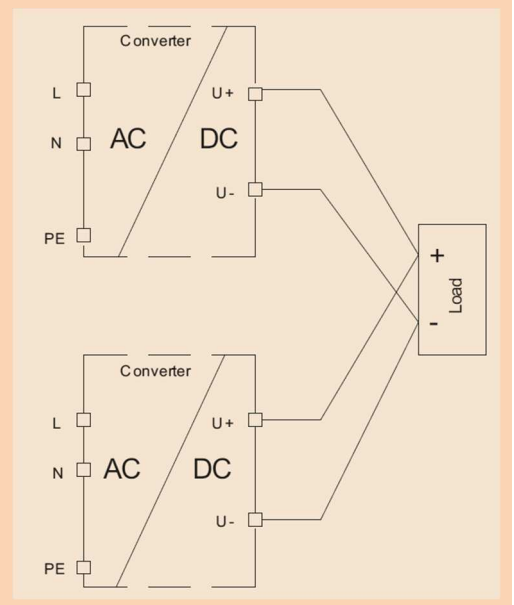

C/V Current Voltage Behaviour

When the HSW is overloaded it goes into the ticker mode. The unit automatically restarts when the load goes below the current limiting. Same happens with a short circuit at the output of the device.

Coating Option

We offer the HSW-series with optional coating. It is to be used in e.g. dusty, dirty, high humidity, or in awaiting quick temperature changes. Short circuit and corrosion at print board lines and at solder points can be prevented. The coat itself is a transparent acrylic resin. Peters SL 1306 N-FLZ (transparent) IEC60216-1 2001, IPC-CC-830B, UL listed as permanent coating File No.: E80315 , UL94V-0

Technical Data Table – Power OK Connection & Voltage Setting

Feature	Technology	Details and Connections	Section	Isolation
Potentiometer Voltage	1 turn	High precision	U adj	3000Vac to input & 500Vdc to output
Power Good Relay	“b” contact	AWG24 – AWG14 / 0,25 – 2,5mm ²	DC-ok	3000Vac to input & 500Vdc to output

DC Voltage setting range

Rated DC Voltage	5Vdc	9Vdc	12Vdc	15Vdc	24Vdc
Rated DC Current	7.5A	7.5A	6.0A	5.0A	3.2A
DC Voltage Setting Range	4.9 - 5.5Vdc	8.6 - 9.9Vdc	11.4 - 13.2Vdc	14.3 - 16.5Vdc	24.0 – 28.0Vdc

The DC voltage can be adjusted with a precision 1 turn potentiometer with low temperature fading. The factory setting is to the rated voltage from the table above.

DC-OK Relay

The DC ok relay indicates if the output voltage is low and if the AC voltage is low. The contact is galvanic insulated to the AC input and the DC output connections. The isolation to the AC input is 3000Vac with a forced isolation and covers the overall adjustment range of the HSW models. If the DC voltage is ok the relay is closed, if the power supply unit is in false operation the relay is open. Considering the lower and the upper margin of the AC voltage detection it is to say that the HSW series starts at 85Vac. The unit starts with 85Vdc when a DC voltage applies to the input.

DC-Fail hysteresis: drop-out 20% $V_{nominal}$ / pull-in 60% $V_{nominal}$.
Contact Rating 30Vdc/1A, 60Vdc/0.3A, 30Vac/0.5A

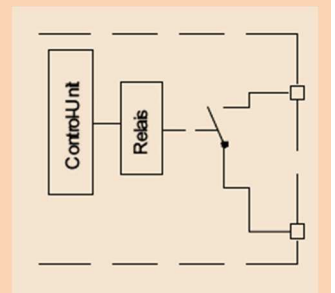

DC OK Indication

Power Supply Status	Normal	AC Low [V]	DC Low [V]
Relay Operation status	Closed	Open	Open

Sense Function

The model HSW00751.005 has a Sense Mode to compensate for the voltage drop over long load lines. The compensation amounts to a maximum of 0,2V per load line. **WARNING!** Reverse polarity of the sense lines can cause damages to the power supply unit.

Electrical Safety (Factory-Test / Field-Test Owner)

	T	A	B	C	D
Type Test	60s	2500Vac	3000Vac	500Vdc	500Vdc
Factory Test	5s	2000Vac	1000Vac	500Vdc	500Vdc
Field Test	2s	2000Vac	1000Vac	500Vdc	500Vdc
Cut-off current setting	>10mA	>10mA	>1mA	>1mA	>1mA

Type and factory test are the manufacturer. While repeating damage can happen to the power supply unit. For the field test (owner) follow the below instruction:

- Use suitable test equipment, raising the voltage slowly.
- Short circuit L1 and N, and all the DC output terminals.
- Use only test voltages of 50/60Hz. The outputs are unearthed and therefore they have no resistance to GND/PE.
- If the residual voltage is $\geq 60Vdc$, observe the safety standards. Use only specially insulated screwdriver to trim the Ua/la.

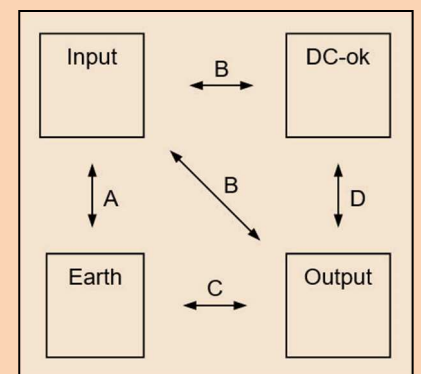

Mechanics

Mechanics & Installation Instruction of the HSW

Stable metal/aluminium housing IP20. To allow adequate convection, a free air space of 50mm (top/bottom) and 10mm (sidewalls) is required; and for active devices 15mm space from the sidewalls. One can use the DIN-Rail installation (equipped standard) with our patented 35mm DIN-Rail bracket according to EN60715. It is easy to mount/dismount while snapping it onto the 35mm DIN-Rail - no tools necessary. **It is not allowed to install the HSW in other mounting direction then below drawings.**

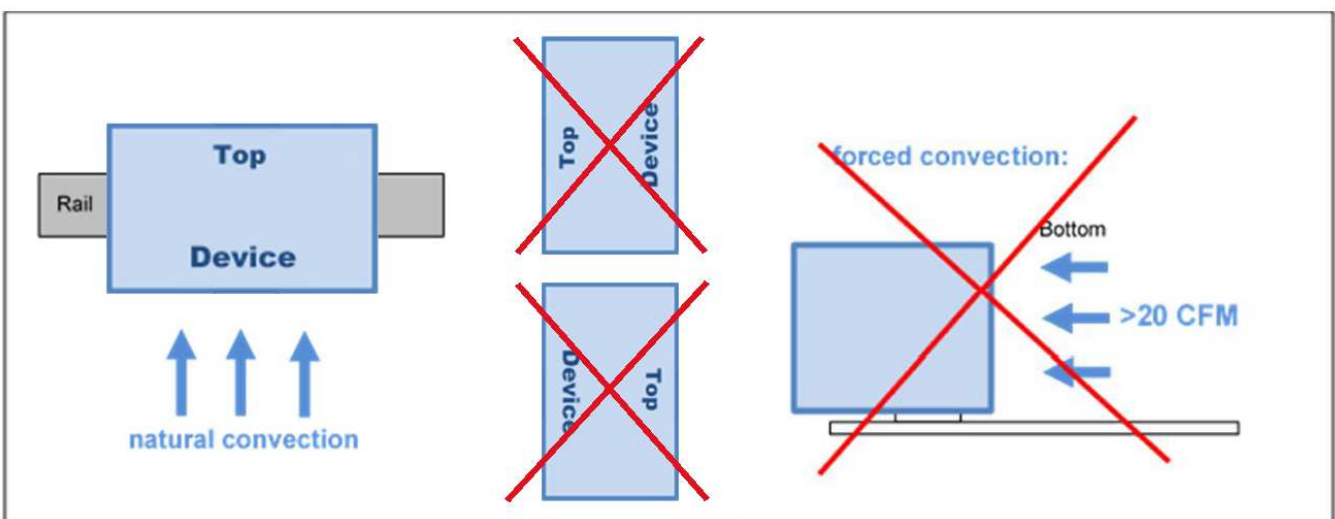
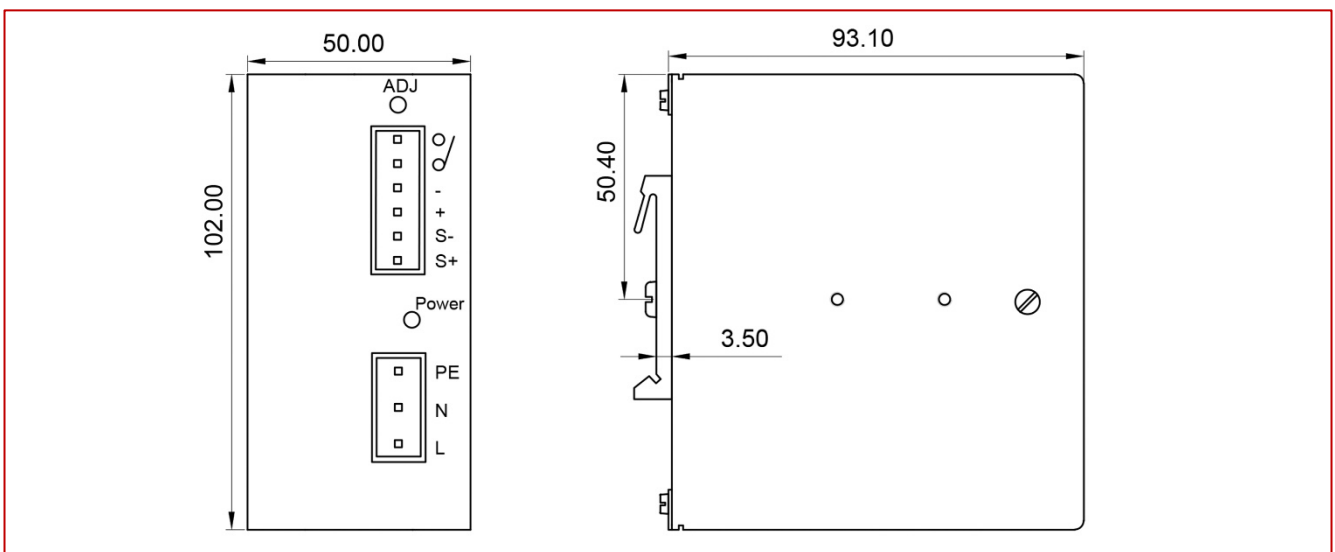

Mounting Instruction: recommended airflow space below and above is 50mm (2 Inch)

Connections

Clamping Yoke Connector Specifications

	Optional Connection Plugs Input	Optional Connection Plugs Output, Power OK & Sense
Tightening torque min. – max.	0,4 – 0,5Nm (blade 0,6x3,5 PH1 PZ1)	0,4 – 0,5Nm (blade 0,6x3,5 PH1 PZ1)
Touch-safe protection acc. to DIN VDE 0470	Not applicable	Not applicable
Clamping range, min. – max.	0,2 – 4,0mm ² / AWG26 – AWG12	0,2 – 4,0mm ² / AWG26 – AWG12
Solid, H05(07) V-U min. – max.	0,2 – 4,0mm ²	0,2 – 4,0mm ²
Stranded, H05(07) V-U min. – max.	Not applicable	Not applicable
Flexible, H05(07) V-U min. – max.	0,2 – 4,0mm ²	0,2 – 4,0mm ²
w. plastic collar ferrule, DIN 46228 pt 4 min. – max.	0,2 – 2,5mm ²	0,2 – 2,5mm ²
w. wire end ferrule, DIN 46228 pt 1, min. – max.	0,2 – 4,0mm ²	0,2 – 4,0mm ²
Plug gauge in accordance with EN 60999 a x b; ø	2,8 x 2,4mm; 2,5mm	2,8 x 2,4mm; 2,5mm
Pitch (P)	7,50mm	5,08mm

Wire Stripping Length (fine wired)

Nominal Cross Section	Wire End Ferrule	Stripping Length	Wire End Ferrule	Stripping Length
0,25mm ²	H0,25/5	5mm	H0,25/10 HBL	8mm
0,5mm ²	H0,5/6	6mm	H0,5/12 OR	8mm
1,0mm ²	H1,0/6	6mm	H1,0/12 GE	8mm
2,5mm ²	H2,5/12	12mm	H2,5/19D BL	14mm
4,0mm ²	H4,0/12	12mm	H4,0/20 GDR	14mm

The length of ferrules is to be chosen depending on the rated voltage. The outside diameter of the plastic collar should not be larger than the pitch (P)

Ordering Information

Ordering Codes

Product Code	Information	Article Number
HSW00751.005(R2)	5V	3041034002CA
HSW00751.009(R2)	9V	3041034003CA
HSW00751.012(R2)	12V	3041034004CA
HSW00751.015(R2)	15V	3041034005CA
HSW00751.024(R2)	24V	3041034007CA
Optional Power OK & Output Connectors	Optional, 2poles Clamping Yoke Connector 180° cabling (10pcs per pack)	3520037
Optional Input Connector	Optional, 3poles Clamping Yoke Connector 180° cabling (10pcs per pack)	3520038



Safety regulations: Please read these instructions completely before using the equipment. Keep these instructions on to hand. The device may only be operated by trained specialist staff.

Installation:

- 1) The device is designed for devices and systems that meet the standard requirements for hazardous voltages, power, and fire prevention.
- 2.) Installation and service only by trained specialists. The AC power must be switched off. The work is to be labelled; accidental reconnection of the system must be prevented.
- 3.) Opening the device, its modification, loosening bolts, or operation outside the specified herein specification or in an unsuitable environment, has the immediate loss of warranty to follow. We disclaim any responsibility for any resulting damage to persons or things.
- 4.) Note: The device must not be operated without an upstream circuit breaker (CB). We recommend the use of B-type 8A. It is prohibited to use the unit without PE. It may be necessary upstream device has a power switch.

Warning:

Non-compliance these warnings can result in fire and serious injury or death.

1. Never operate device without PE connection.
2. Before connecting the device to the AC network, make wires free of voltage and ensure that it cannot accidentally switch on.
3. Allow neat and professional cabling.
4. Never open nor try to repair the unit. Inside are dangerous voltages that can cause electrical shock hazard.
5. Avoid metal pieces or other conductive material to fall into the item.
6. Do not operate the device in damp or wet conditions
7. Do not operate the unit under EX-conditions



All parameters base on 15 minutes run-in @ full load / 25°C / 230Vac 50/60Hz, as otherwise stated.