

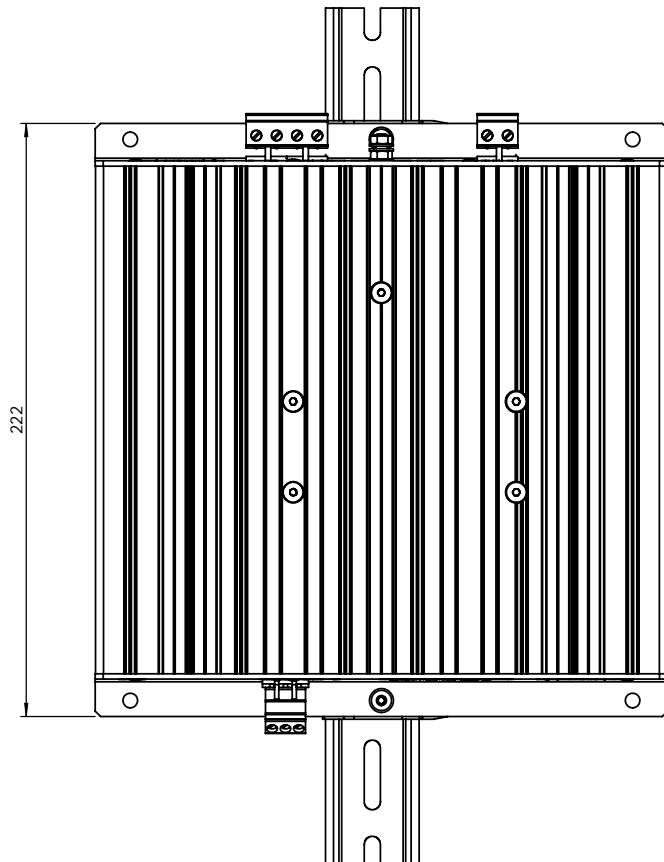

This document is the property of Polyamp AB and shall not, without the permission of Polyamp AB, be allowed, copied, used for manufacturing or communicated to any other person or company.

Weight (kg/m3)	Replaces dwg	Page 1(1)	Associated dwg No	Units millimeters	Scale 1:2	Rev No 00
		PM500 Series Standard Wall mounting		Tolerances/Tolerances ISIRI 7161.1 m Rjmmhet/Surf. text RA 6,3		Designer roand Date (y/m/d) 130423 Approved by Date (y/m/d) - Rev by Date (y/m/d) -
Dwg No						PM500_04

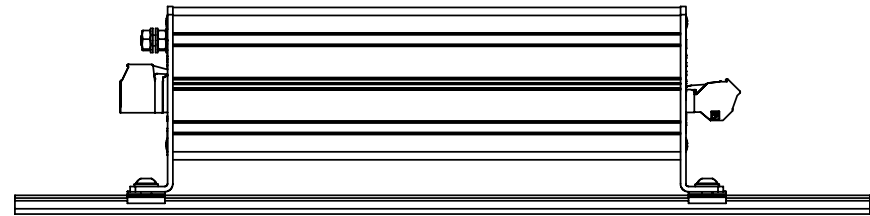
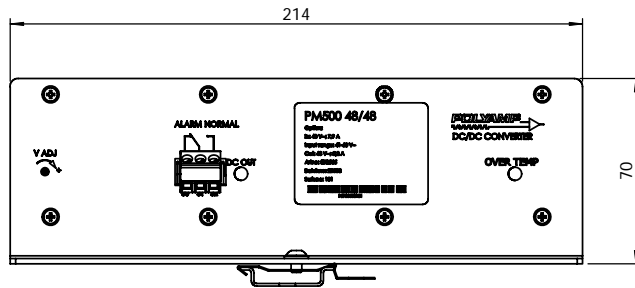

This document is the property of Polyamp AB and shall not, without the permission of Polyamp AB, be allowed, copied, used for manufacturing or communicated to any other person or company.

Weight (kg/m3)	Replaces dwg	Page 1(1)	Associated dwg No	Units millimeters	Scale 1:2	Rev No 00
	PM500 Series Standard DIN rail mounting TS35		Tolerances/Tolerances BS482 2/3&1		Designer roand	Date (y/m/d) 130423
			m		Approved by	Date (y/m/d)
			RA 6,3		Rev by	Date (y/m/d)
					Dwg No	PM500_08

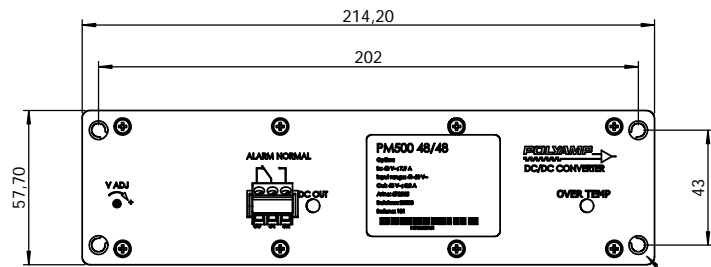

M6, depth 20mm (8x)

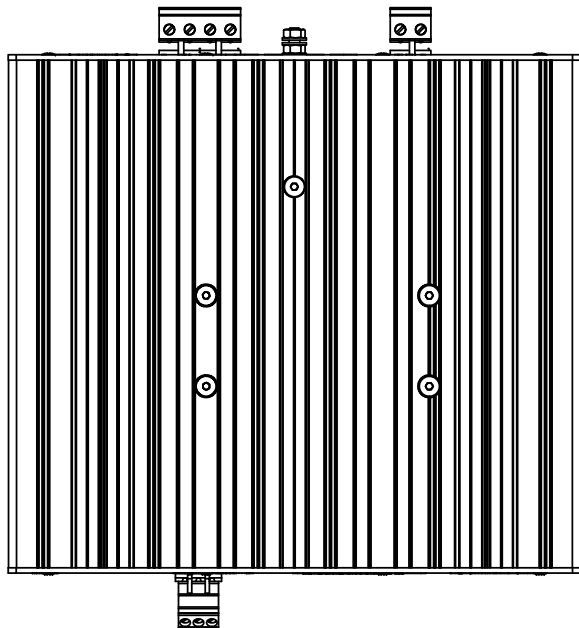
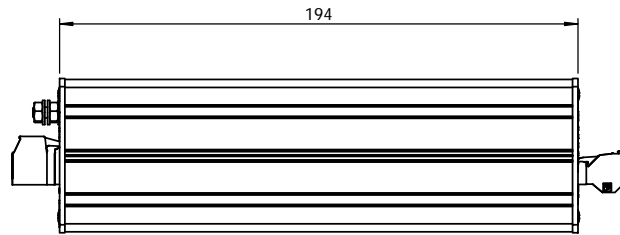

This document is the property of Polyamp AB and shall not, without the permission of Polyamp AB, be allowed, copied, used for manufacturing or communicated to any other person or company.

Weight (kg/m3)	Replaces (dwg)	Page 1(1)	Associated (dwg No)	Units millimeters	Scale 1:2	Rev No 00	
		PM500 Series Option R		Tolerances/Tolerances IS:ISO 2768:1 m NjmmHes/Surf. text RA 6,3		Designer roand Date (y/m/d) 150218 Approved by Date (y/m/d) Rev by Date (y/m/d)	
				Dwg No		PM500_12	

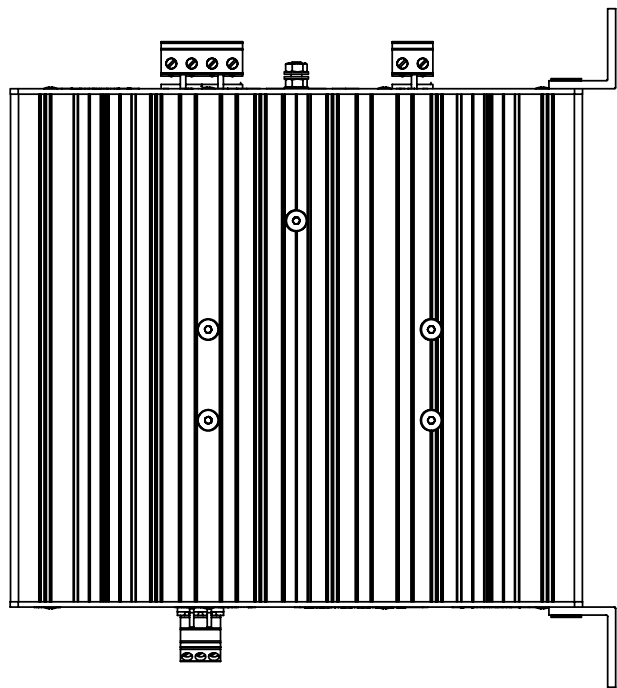
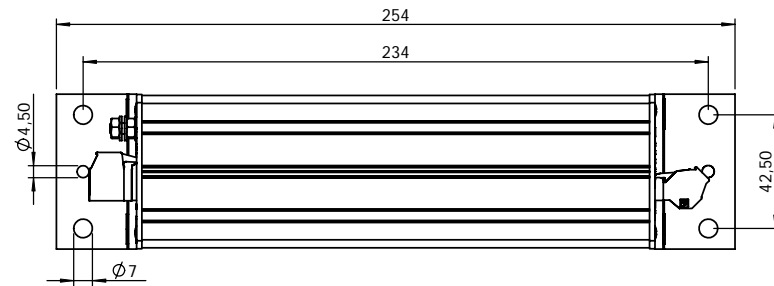
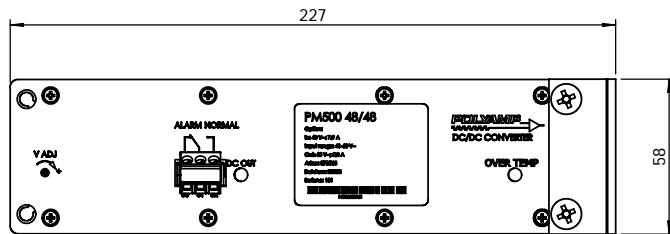

This document is the property of Polyamp AB and shall not, without the permission of Polyamp AB, be allowed, copied, used for manufacturing or communicated to any other person or company.

Weight (kg/m3)	Replaces (dwg)	Page 1(1)	Associated (dwg No)	Units millimeters	Scale 1:2	Rev No 00
		PM500 Series Option 400065 Wall mounting 400065		Tolerances/Tolerances ISIRI 7161.1 m RA 6,3		Designer roand Date (y/m/d) 130423 Approved by Date (y/m/d) Rev by Date (y/m/d)
Dwg No.						PM500_02

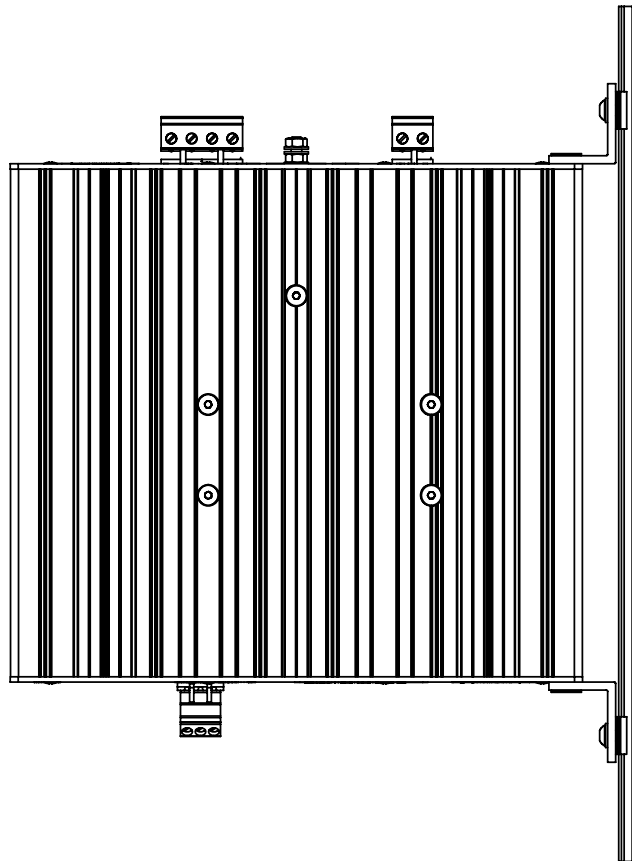
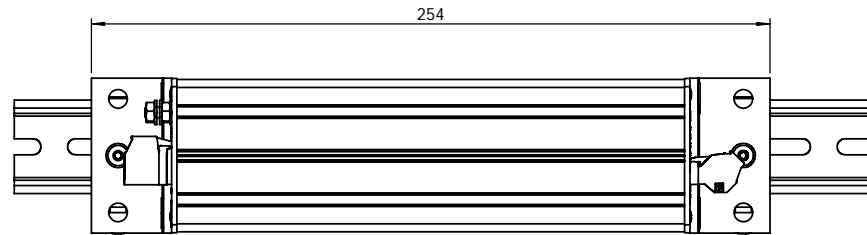
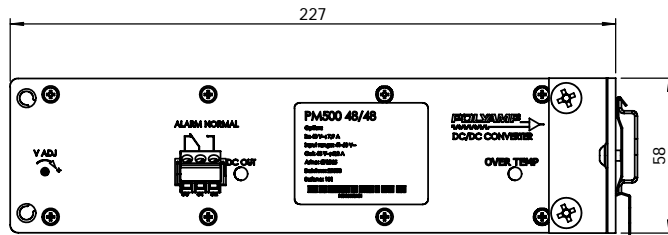

This document is the property of Polyamp AB and shall not, without the permission of Polyamp AB, be allowed, copied, used for manufacturing or communicated to any other person or company.

Weight (kg/m3)	Replaces (dwg)	Page 1 (1)	Associated (dwg) No.	Units millimeters	Scale 1:2	Rev No. 00
		PM500 Series Option 400065 DIN rail mounting TS35 400065		Tolerances/Tolerances ISIRI 7161.1 m Rjmmhet/Surf. text RA 6,3		Designer roand Date (y/m/d) 130423 Approved by Date (y/m/d) - Rev by Date (y/m/d) -
Dwg No.						PM500_03

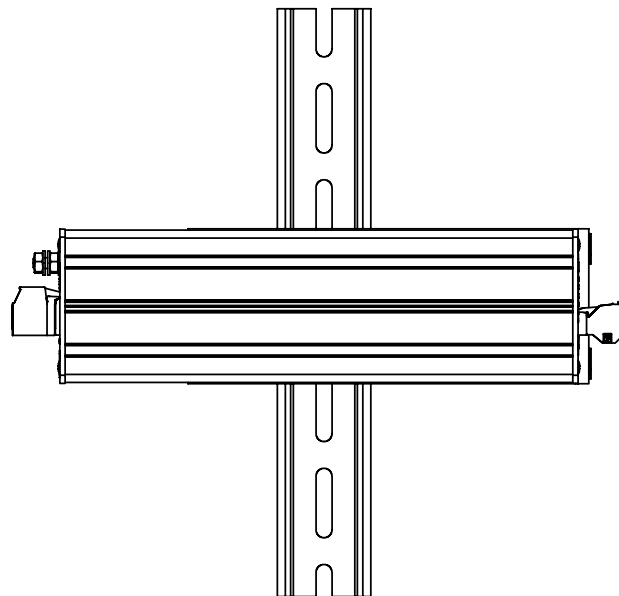
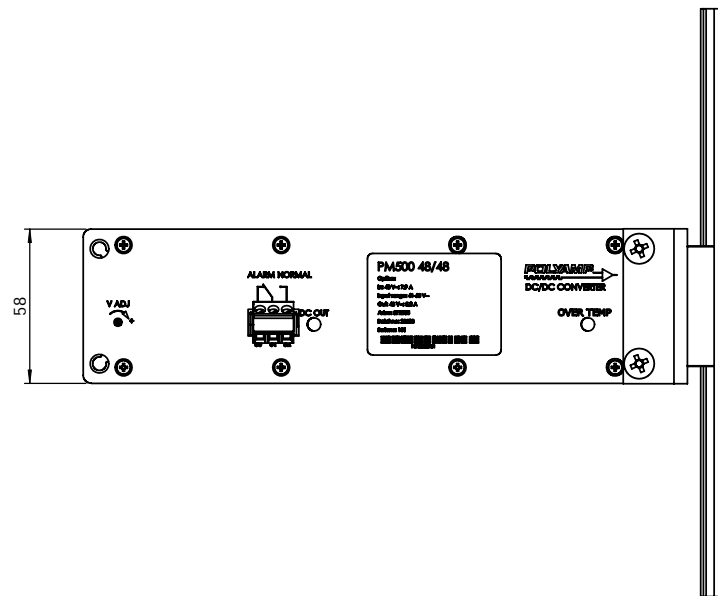
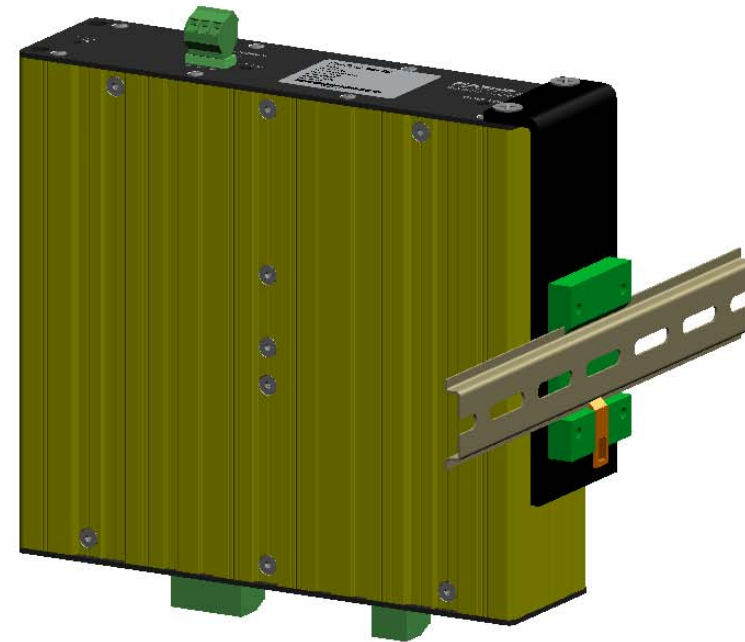
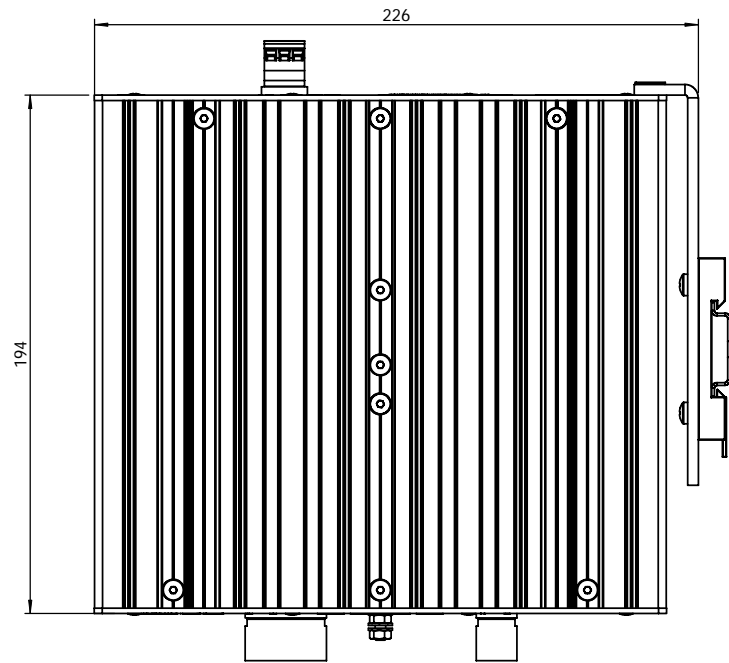

This document is the property of Polyamp AB and shall not, without the permission of Polyamp AB, be allowed, copied, used for manufacturing or communicated to any other person or company.

A3

Weight (kg/m3)	Replaces dwg	Page 1(1)	Associated dwg No.	Units millimeters	Scale 1:2	Rev No 00
	PM500 Series Option 400064 DIN rail mounting TS35 400064		Tolerances/Intolerances IS:ISO 2768-1 m Njmmhht/Surf. text RA 6,3		Designer roand Date (y/m/d) 130423	Approved by Date (y/m/d)
			Rev by Date (y/m/d)		Date (y/m/d)	
			Dwg No.		Date (y/m/d)	
			Date (y/m/d)		Date (y/m/d)	
					PM500_05	

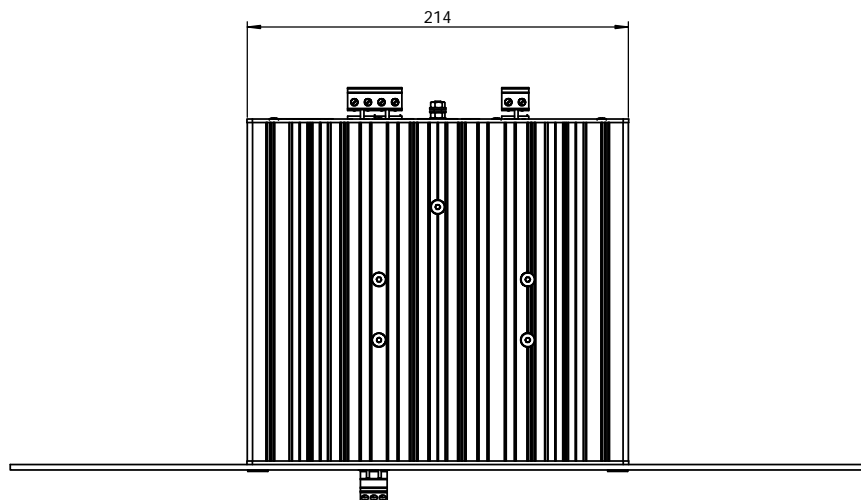
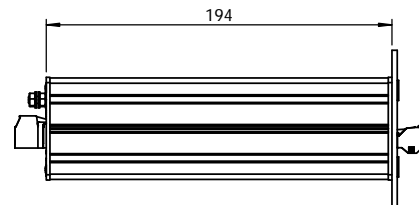
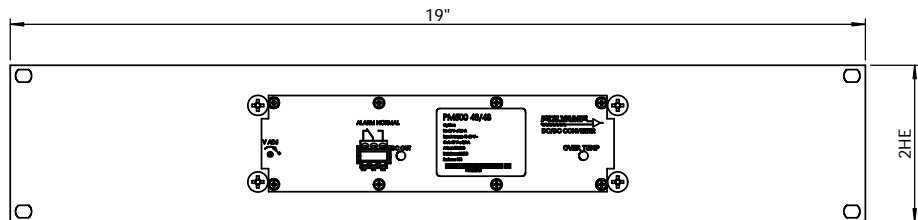

This document is the property of Polyamp AB and shall not, without the permission of Polyamp AB, be allowed, copied, used for manufacturing or communicated to any other person or company.

Weight (kg/m ³)	Replaces drawing	Page 1(1)	Associated drawing No.	Units millimeters	Scale 1:3	Rev No. 00
	PM500 Series Option 400061 19" mounting 1 unit 400061			Tolerances/Tolerances IS:ISO 2768-1 m	Designer roand Date (y/m/d) 131101	Approved by Date (y/m/d)
				Tjennhet/Surf. test RA 6,3	Rev by Date (y/m/d)	Date (y/m/d)
				Dwg No.	PM500_011	

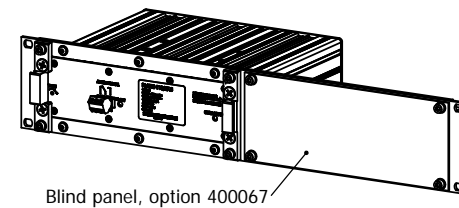
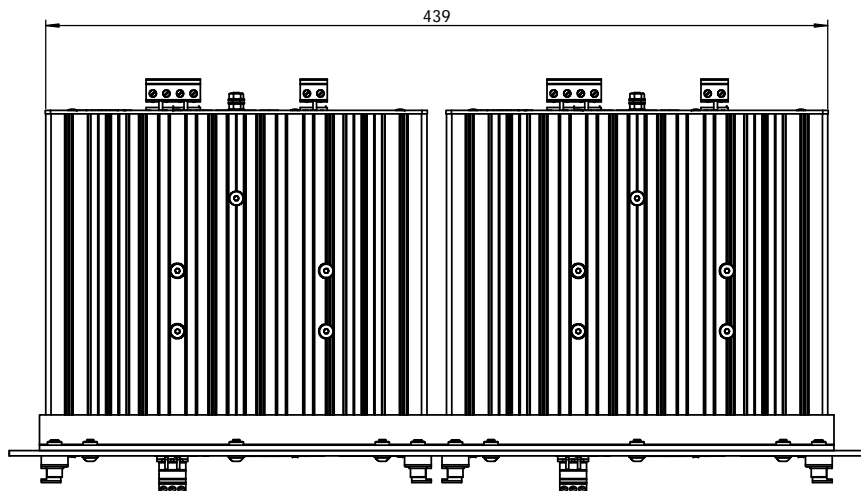
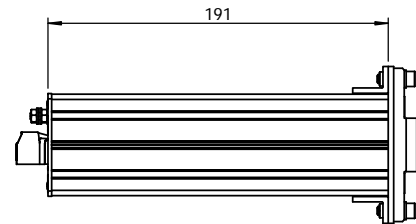
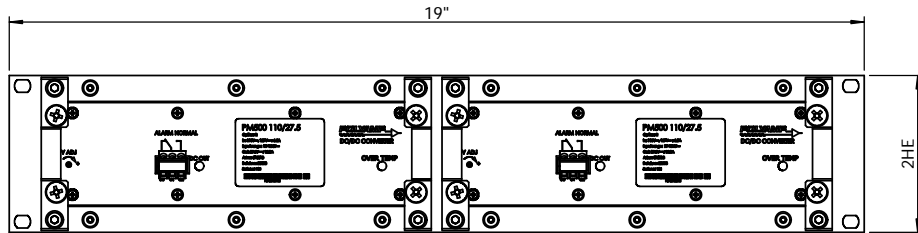

Blind panel, option 400067

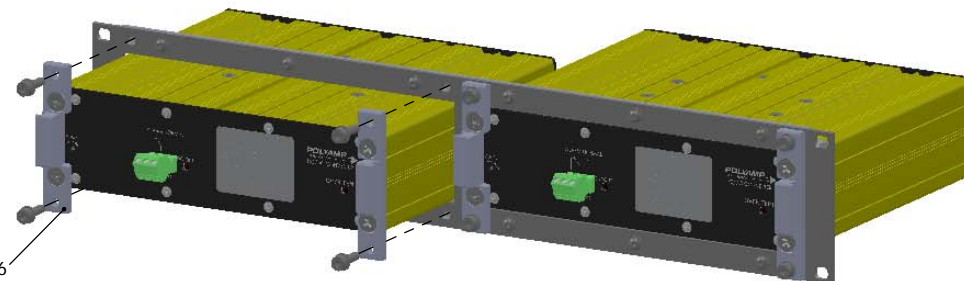

Handle, option 400066

This document is the property of Polyamp AB and shall not, without the permission of Polyamp AB, be allowed, copied, used for manufacturing or communicated to any other person or company.

Weight (kg/m3)	Replaces dwg	Page 1(1)	Associated dwg No	Units millimeters	Scale 1:3	Rev No 00
	PM500 Series Option 400062 19" mounting 2 units 400062		Tolerances/Tolerances ISO 2768-1		Designer roand	Date (y/m/d) 130423
			m		Approved by	Date (y/m/d)
			RA 6,3		Rev by	Date (y/m/d)
			Dwg No		PM500_06	

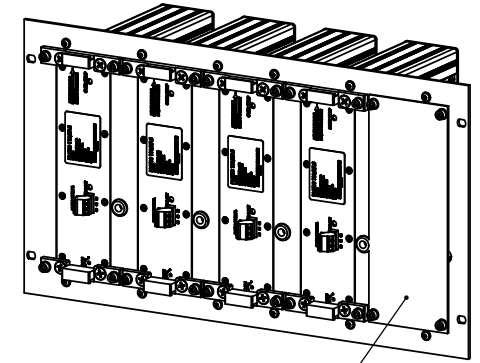
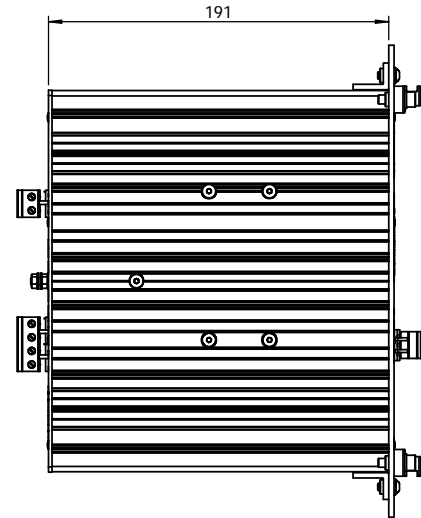
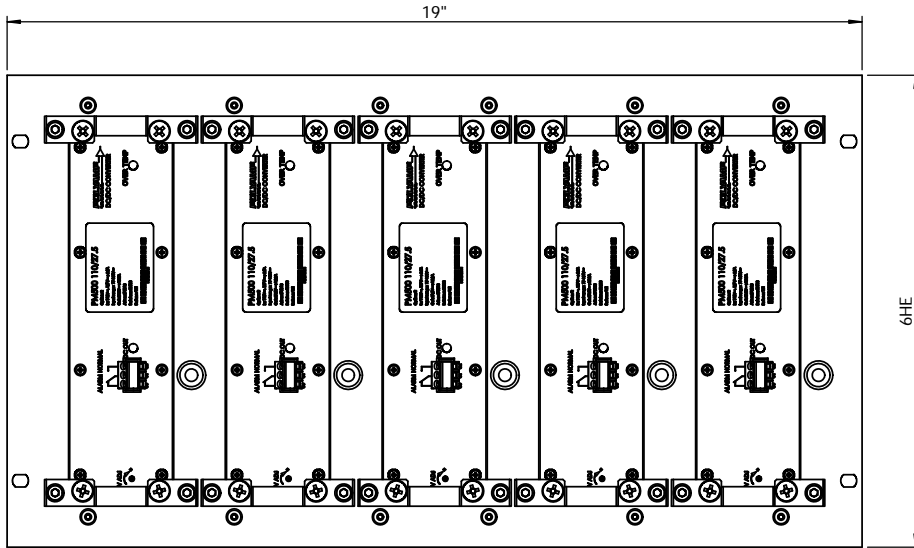

Blind panel, option 400067

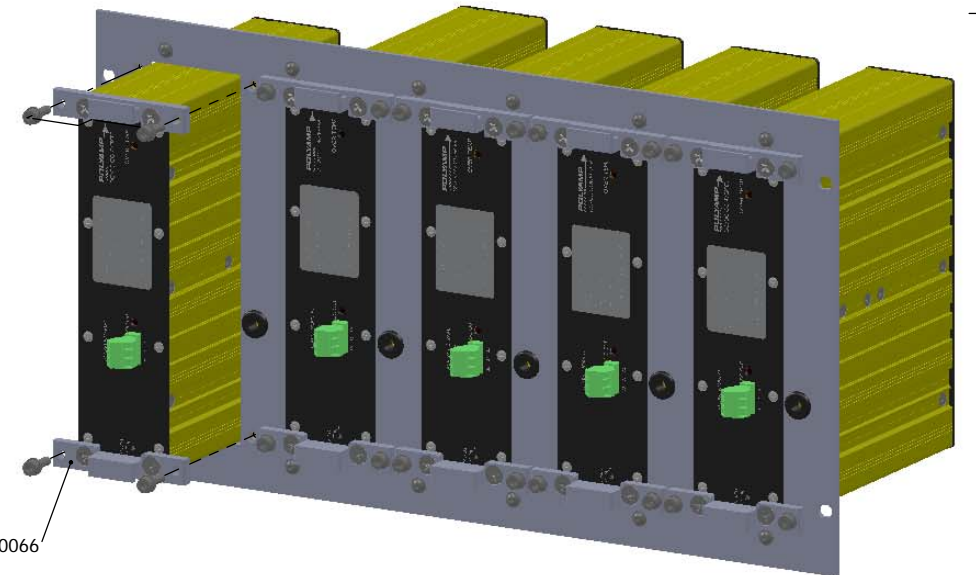
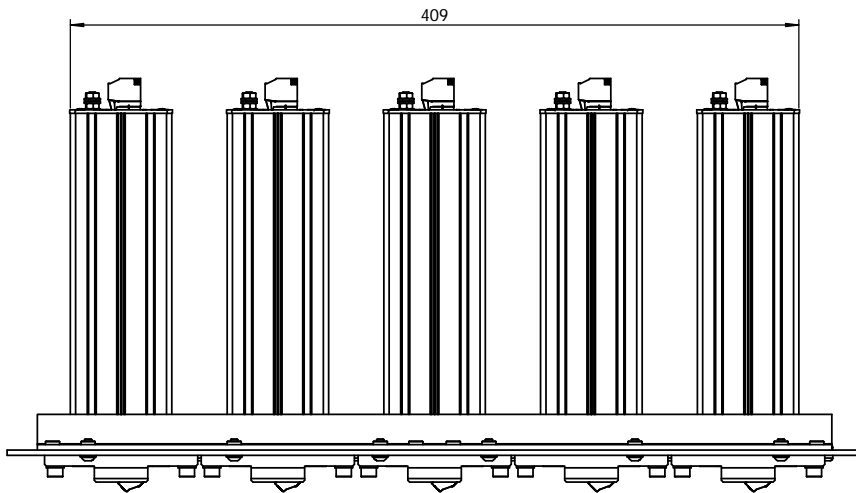

Handle, option 400066

Weight (kg/lb)	Replaces dwg	Page 1(1)	Associated dwg No.	Units millimeters	Scale 1:3	Rev No 00
	PM500 Series Option 400063 19" mounting 5 units 400063		Tolerances/Tolerances ISO 2768-1	Designer roand	Date (y/m/d) 130423	
			Approved by m	Rev by	Date (y/m/d)	
			RA 6,3	Rev by	Date (y/m/d)	
			Dwg No.	PM500_07		

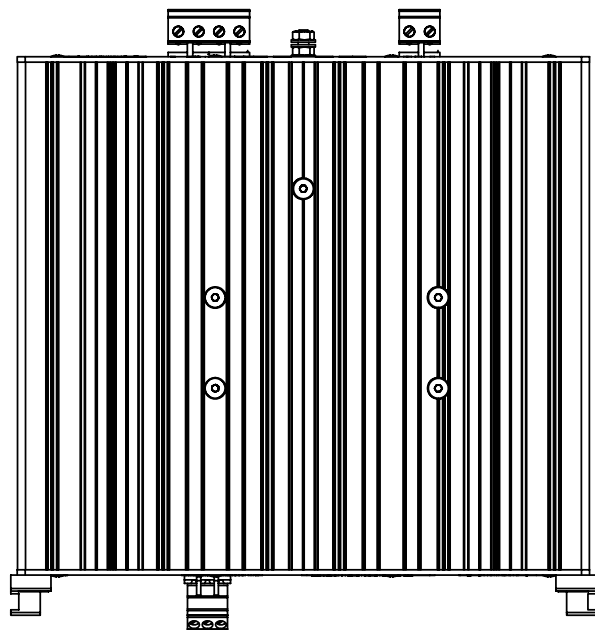
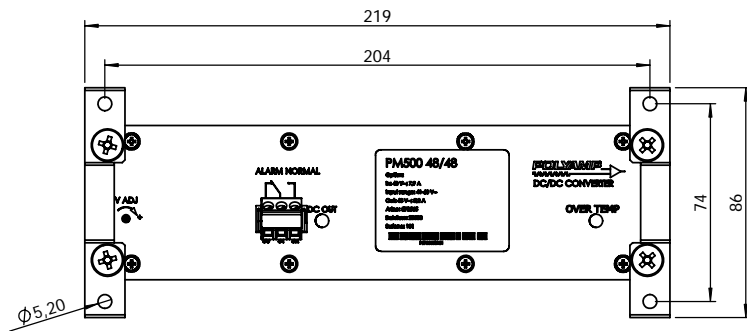

Including
Screw MC6S M5X16 4pcs
Washer BRB M5 4pcs

This document is the property of Polyamp AB and shall not, without the permission of Polyamp AB, be allowed, copied, used for manufacturing or communicated to any other person or company.

Weight (kg/m ³)	Replaces dwg	Page 1(1)	Associated dwg No	Units millimeters	Scale 1:2	Rev No 00
	PM500 Series Option 400066 Flat panel with handle 400066		Tolerances/Tolerances IS:ISO 2768-1 Designer round Date (y/m/d) 130423		Approved by _____ Date (y/m/d) _____ RA 6,3 Rev by _____ Date (y/m/d) _____	
			Dwg No. _____		PM500_09	

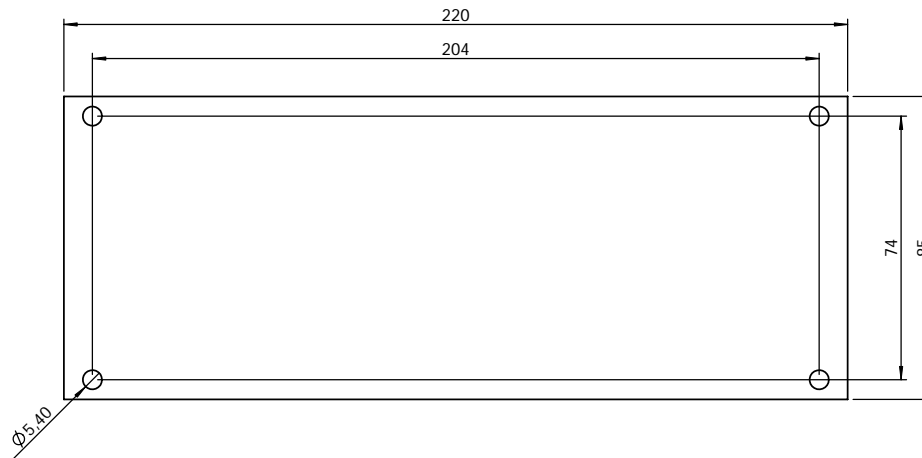
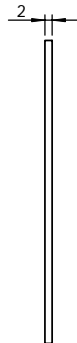

Including
Screw MC6S M5X12 4pcs
Washer BRB M5 4pcs

This document is the property of Polyamp AB and shall not, without the permission of Polyamp AB, be allowed, copied, used for manufacturing or communicated to any other person or company.

Weight (kg/m ²)	Replaces dwg	Page 1(1)	Associated dwg No.	Units millimeters	Scale 1:1.5	Rev No 00
	PM500 Series Option 400067 Blind panel 400067		Tolerances/Intolerances ISO 2768-1		Designer roand	Date (y/m/d) 130423
			m		Approved by	Date (y/m/d)
			RA 6,3		Rev by	Date (y/m/d)
			Dwg No.		PM500_010	