

# TC.ACS.50.528.4WR.HC.LC

## Programmable Bidirectional AC Power Source



### Features

#### Scope of Application

The increasing number of alternative power sources like solar, wind driven or biological energy systems call for consistent and well demanding regulations for energy feed into the utility grid.

Manufacturers of such systems have to test and to prove the compliance of their equipment.

REGATRON TC.ACS represent the newest generation of fully programmable, full 4-quadrant grid simulation systems. Modular architecture and additional operation modes make them an ideal choice for test and R+D laboratories.

#### TC.ACS - Programmable Parameters

- Each phase individually programmable
- Variation of fundamental frequencies up to 1000 Hz
- Variation of phase angles
- Variation of amplitudes
- Step changes of fundamental frequency
- Voltage drops either three phase or each single phase
- Asymmetric three phase voltages
- Micro-ruptures and flicker
- Periodic and single shot under- and over-voltages
- Superimposed harmonic and inter-harmonic voltages up to 5 kHz
- Specialized software for EMC characterisation

#### The Grid Simulation System as a Building Block of a Complete Test Environment

Owing to the full 4-quadrant capability of the TC.ACS system, almost all AC power equipment can be tested with the appropriate test procedures. An integrated test environment for solar inverters is composed of a Solar Array Simulation block (SAS), the device under test (DUT) and the grid simulator system (ACS). While the REGATRON SAS components allow for precise simulation of a user-defined solar array of any order under arbitrary conditions, the ACS simultaneously defines the different test conditions with respect to the grid connection. Depending on the requirements, the ACS functionality may be tailored with various software options. In addition to the *Basic Waveform Generator Mode* and the *Amplifier Mode*, which are within the standard scope of delivery, the options *Full Waveform Generator Mode* with *Fourier Synthesis Tool*, *Current controlled Amplifier Mode* and *Load Simulation Mode* are available.

#### Software

An intuitive application based software with various options allows for manual operation, programming and for automated test runs. With the optional *Full Waveform Generator Mode* (GridSim) a set of predefined voltage shapes – sine, cut sine, square, triangle, sawtooth, user defined - facilitates a quick and easy definition of specific grid situations. This software option also offers freely programmable modulations on each phase for amplitude, frequency and phase angle.

#### Hardware

REGATRON grid simulator systems use a state of the art multilevel double inverter technology. The main advantages over existing linear power supplies are a substantial reduction of power losses, full 4-quadrant operation, very compact power units and the modular, cost-effective architecture. This allows the user to choose a system size well-fitting his requirements, including the possibility for future power expansions and/or splitting-up of the system into several stand-alone subsystems. The basic triphase power units of 30 kVA or 50 kVA may be expanded by simply paralleling further blocks even to big systems reaching 2000+ kVA.

Even higher power levels may be achieved by means of multi-system operation.

With the availability of the active neutral string, any single phase or asymmetric condition can be simulated. Additionally, the neutral can be connected to Protective Earth (PE), if required.

The system will allow for all relevant testing according to the grid-feed-in regulations (CENELEC, DIN, IEC). Note the operation as a grid simulator, as fast triphase full 4-quadrant voltage amplifier and as a programmable electronic load are possible.

#### Application Example

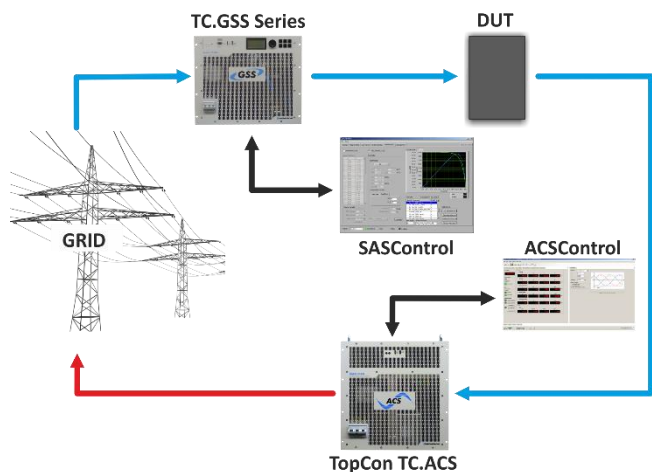

By the addition of a bidirectional regenerative DC power supply TC.GSS or G5 to such a test environment, even the role of an energy storage pack within the setup may be experienced.

REGATRON offers complete and modular SAS systems based on the widespread, field-proven TopCon Quadro and the G5 power supplies on one hand as well as complete grid simulation on the other hand. Modern switched-mode technology ensures very compact and reliable systems with high overall efficiency.

## Technical Data

### Key Values

Programmable Bidirectional AC Power Source	
Power range	0...50 kVA
Voltage range	3 x 0...305 V <sub>ACrms</sub> (L-N)
Current range	3 x 0...75 A <sub>ACrms</sub>
Master-slave / multi-device configuration	parallel
Max. number of devices in system	up to 50
Case	19" / 11U

### AC Lineside Ratings (X10)

#### Mains connection

Mains connection type	3L + PE (no neutral)	
Line voltage	3 x 360...528 V <sub>ACrms</sub>	
Input current	3 x 360 V <sub>ACrms</sub> / 90 A <sub>rms</sub>	
	3 x 400 V <sub>ACrms</sub> / 81 A <sub>rms</sub>	
	3 x 440 V <sub>ACrms</sub> / 74 A <sub>rms</sub>	
Input current	3 x 480 V <sub>ACrms</sub> / 68 A <sub>rms</sub>	
	48...62 Hz	
Powerfactor @nominal power	1	
Precharge unit provided. No excessive inrush current.		
THDi @90% P <sub>max</sub>	<1%	
Input filter discharge to <60 V	<20 s	
	with option XCD	<1 s

#### Isolation

Power to PE (L1 / L2 / L3)	working voltage	305 V <sub>ACrms</sub>
Power to PE (L1 / L2 / L3)	working voltage	432 V <sub>DC</sub>
Power to case/logic	test voltage	2120 V <sub>DC</sub> / 1 s

### Loadside Ratings (X20)

#### Static Accuracy

Voltage (RMS-controller)	0.05% FS
Voltage general	<1.5 V
Frequency	2 mHz
Phase Angle	1°

#### Slew rate (see Figure 5)

Voltage slew rate	≤4 V/μs
10%...90% step of full scale	≤100 μs

#### DC ripple + noise

16 Hz...200 kHz	230 mV <sub>rms</sub>
9 kHz...20 MHz	700 mV <sub>p-p</sub>

#### Overloadability (see Figure 3, 4)

up to 10 s every 600 s	≤150%
up to 1 s every 60 s	≤200%

#### Measurement Precision

Voltage	±0.7% FS
Current	±1.4% FS

#### Setpoint Resolution

Voltage	0.1 V
Frequency	1 mHz
Phase	0.1°

#### Isolation

Power to PE (L1 / L2 / L3 / N)	working voltage	305 V <sub>ACrms</sub>
Power to PE (L1 / L2 / L3 / N)	working voltage	432 V <sub>DC</sub>
Power to case/logic	test voltage	2120 V <sub>DC</sub> / 1 s

### AC Loadside Ratings (X20)

Frequency range (see Figure 2, 3)	0...1000 Hz
Modulation bandwidth	5.0 kHz
DC offset	≤10 mV
Efficiency @nominal power	90%
Output filter capacitance (L-N)	24.7 μF

#### Simulation Port: 3L + N (see Figure 6)

Power range	0...50 kVA
Voltage range	0...305 V <sub>rms</sub> (L-N)
Connection type	3L + N + PE
Current range 3Φ	3 x 0...75 A <sub>rms</sub> <sup>1)2)</sup>
	1 x 0...80 A <sub>rms</sub> <sup>5)</sup>

#### Simulation Port: 1L + N (see Figure 7)

Power range	0...20 kVA
Voltage range	0...305 V <sub>rms</sub> (L-N)
Connection type	L1//L2 + L3//N + PE
Current range 1Φ	0...144 A <sub>rms</sub> <sup>1)</sup>

#### Simulation Port: 2L (see Figure 8)

Power range	0...50 kVA
Voltage range	0...610 V <sub>rms</sub> (L-L)
Connection type	L1//L2 + L3//N + PE
Current range 1Φ	0...144 A <sub>rms</sub> <sup>1)</sup>

#### Harmonic distortion @50 Hz (THDu)<sup>3)</sup>

Linear loads	≤0.4%
Non linear loads	≤1.6%

### DC Loadside Ratings (X20)

#### Configuration 1: one output (symmetric to PE)

Power range	0...±33 kW
Voltage range	0...±830 V <sub>DC</sub>
Connection type	L1//L2 + L3//N
Current range	0...±40 A <sub>rms</sub>

#### Configuration 2: one output (related to PE)

Power range	0...±25 kW
Voltage range	0...±415 V <sub>DC</sub>
Connection type	L1//L2//L3 + N
Current range	0...±60 A <sub>rms</sub>

#### Configuration 3: two independent outputs

Power range	0...±16 kW
Voltage range	0...±830 V <sub>DC</sub>
Connection type	L1 + L2
Current range	0...±20 A <sub>rms</sub>
Power range	0...±8 kW
Voltage range	0...±415 V <sub>DC</sub>
Connection type	L3 + N
Current range	0...±20 A <sub>rms</sub>

#### Configuration 4: three independent outputs (related to PE)

Power range	3 x 0...±8 kW
Voltage range	3 x 0...±415 V <sub>DC</sub>
Connection type	L1 + N / L2 + N / L3 + N
Current range	3 x 0...±20 A <sub>rms</sub> <sup>4)</sup>

1) Current according to the given power limit of the corresponding units

2) Only in CV mode, in CC mode max. 3 x 0...72 A<sub>rms</sub>

3) Up to 290 V<sub>rms</sub> (L-N)

4) Total current in N is limited to 20A

5) The 80 A 2-phase (or split-phase 120 V<sub>AC</sub> - Neutral - 120 V<sub>AC</sub>) can be supported with the following restrictions:

- No other phases under load

- Ambient temperature <25 °C

- The overloadability given on page 4 cannot be guaranteed.

## Technical Data (continued)

### Protection

Built-in Protection	
Overvoltage protection	programmable
Overcurrent protection	programmable

### Internal diagnostics

line input conditions, internal current conditions, temperature conditions, system configuration, system communication, power semiconductor temperatures.

### Type of Protection (according EN 60529)

Basic construction	IP 20
Mounted in cabinet	up to IP 54 <sup>1)</sup>

### Safety Interface

#### ISR (integrated safety relay)

2-channel (2x category 1, PL c according DIN EN ISO 13849-1:2015)

read-back circuit with forcibly guided contacts

PL e possible with 2-channel and external safety relay (optional)

### I/O Interfaces

#### Control Port Input Functions (X610 – X612)

Amplifier mode:	
Voltage setting L1: -432 V...+432 V	-10...+10 V
Voltage setting L2: -432 V...+432 V	-10...+10 V
Voltage setting L3: -432 V...+432 V	-10...+10 V
Maximum input voltage	±30 V
Sampling rate	80 kHz
Time delay input to output	<70 µs
Isolation to electronics and earth	125 V <sub>rms</sub>
Input impedance	20,5 kOhm

#### Trigger ports BNC

Trigger Input X620 (Start)	TTL
Input impedance	10 kOhm
Trigger Output X621 (programmable)	TTL
Output impedance	560 Ohm (short-circuit-proof)
Isolation to electronics and earth	250 V <sub>rms</sub>

#### Analog port 12-pin flush-type (X609)

4 Inputs for general usage	±9.5 V reference voltage
4 Outputs for general usage	±9.5 V reference voltage
Time delay power output to analogue output:	<50 µs
Output pins min. load impedance	2 kOhm
Input pins input impedance	330 kOhm
Sampling rate	80 kHz
Isolation to electronics and earth	250 V <sub>rms</sub>

### Communication Interfaces

#### USB Type B (X607)

Integrated interface for remote control with the operation software ACSControl/API

Isolation to electronics and earth	250 V <sub>rms</sub>
------------------------------------	----------------------

#### Ethernet (X605)

Integrated interface for remote control with the operation software ACSControl/API

Isolation to electronics and earth	200 V <sub>rms</sub>
------------------------------------	----------------------

#### RS232 (X606)

Service interface

Isolation to electronics and earth	125 V <sub>rms</sub>
------------------------------------	----------------------

## General Data

### Weight & Dimension (see Figure 1)

Weight	approx. 150 kg
Width housing	444 mm / 17 ½"
Height housing	489 mm / 19 ¼"
Depth with output terminals	635 mm / 25"

### Terminals

Screw terminals for 6...35mm <sup>2</sup> wires	d ≤8.5mm
AC lineside terminals	3L + PE
AC loadside terminals	3LN + PE

### Ambient

Operating temperature	5...40 °C
Storage temperature	-18...70 °C
Relative air humidity (non-condensing)	0...95%
Installation altitude	0...2000 m above sea level <sup>2)</sup>
Installation	in 19" switch cabinet IEC 60721-3-3 indoor, air-conditioned
Vibration	IEC 60068-2-6 Test Fc
Operating orientation	upside
Storage, transport orientation	upside
Acoustic noise level	≤74 dB @1 m

### Liquid Cooling (LC) Specifications

#### (air-cooling possible with optional TC.LAE)

Material	Al
Inlet/outlet on rear side size	G ½"
Liquid temperature inlet (non-condensing)	15...50 °C
Minimum flow rate	2.5 l/min
Recommended flow rate	5 l/min
Maximum inlet temperature	25 °C @2.5 l/min 40 °C @5 l/min 50 °C @8 l/min
Operation pressure max.	4 bar
Pressure drop	70 mbar @5 l/min
Use cooling liquid with a 30% share of Antifrogen N® within a closed circuit	

### Standards

Protection class	I
Overvoltage category	III
Degree of pollution	2
Area of application	industrial

### Approval CE

Low Voltage Directive 2014/35/EU	EN 62477-1:2012 + A11 :2014 + A1 :2017 + A12 :2021
EMC Directive 2014/30/EU	
EMC immunity (industrial)	EN 61000-6-2:2005
EMC emission (industrial)	EN 61000-6-4:2007 + A1:2011
RoHS Directive 2011/65/EU	EN IEC 63000:2018

### Approval UKCA

Electrical Equipment (Safety) Regulations 2016	BS EN 62477-1:2012 + A11 :2014 + A1 :2017 + A12 :2021
Electromagnetic Compatibility Regulations 2016	
EMC immunity (industrial)	BS EN 61000-6-2:2005
EMC emission (industrial)	BS EN 61000-6-4:2007 + A1:2011
The Restriction of the Use of Certain Hazardous Substances in Electrical and Electronic Equipment Regulations 2012	BS EN IEC 63000:2018

1) slight temperature derating possible depending on ambient temperature inside cabinet.

2) above 1000 m, slight temperature derating possible

## User Software

### Application Software ACSControl

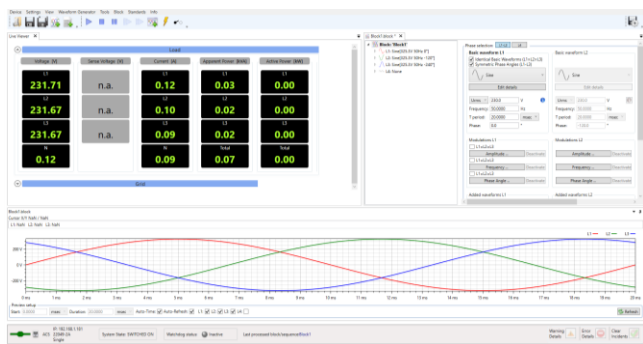

## Software Options

### ACSControl integrated

Full Waveform Generator Mode	(GridSim)
Load Simulation Mode	(RLC load)
Current Controlled Amplifier Mode	(Current Control)

### EMC Test Sequences, preprogrammed:

IEC/EN 61000-3-2	IEC/EN 61000-4-11
IEC/EN 61000-3-3	IEC/EN 61000-4-13
IEC/EN 61000-3-11	IEC/EN 61000-4-14
IEC/EN 61000-3-12	IEC/EN 61000-4-27
	IEC/EN 61000-4-28
	IEC/EN 61000-4-34

## Hardware Options

### Senseboard for RMS voltage drop compensation

with programmable transformer ratio

#### 1500 V type, maximum input voltages:

L-L, L-N, L-PE:	1000 V <sub>rms</sub> , 1500 V <sub>p</sub>
N-PE:	500 V <sub>rms</sub> , 750 V <sub>p</sub>

#### 750 V type, maximum input voltages:

L-L:	860 V <sub>rms</sub> , 1290 V <sub>p</sub>
L-N:	500 V <sub>rms</sub> , 750 V <sub>p</sub>
N-PE:	500 V <sub>rms</sub> , 750 V <sub>p</sub>

#### 500 V type, maximum input voltages:

L-L:	570 V <sub>rms</sub> , 860 V <sub>p</sub>
L-N:	330 V <sub>rms</sub> , 500 V <sub>p</sub>
N-PE:	500 V <sub>rms</sub> , 750 V <sub>p</sub>

### Digital I/O Interface

8 x Digital IN	24 V <sub>DC</sub>
8 x Digital OUT	24 V <sub>DC</sub>
4 x Relays	potential free SPDT

### TC.ACS X609 Adapter (Analog I/O Adapter)

4 x Analog IN	±9.5 V <sub>DC</sub>
4 x Analog OUT	±9.5 V <sub>DC</sub>

### TC.ACS.CANmp Interface

2 x D-Sub 9 pin male connector	CAN interface
8 x Digital IN	24 V <sub>DC</sub>
8 x Digital OUT	24 V <sub>DC</sub>

### Air Cooling

#### External Liquid to Air Heat Exchanger (TC.LAE)<sup>1)</sup>

In addition to the internal Liquid Cooling (LC)

Max. Power @40 °C ambient temperature	35 kVA
Max. Power @35 °C ambient temperature	45 kVA
Max. Power @32 °C ambient temperature	50 kVA

## Dimensions

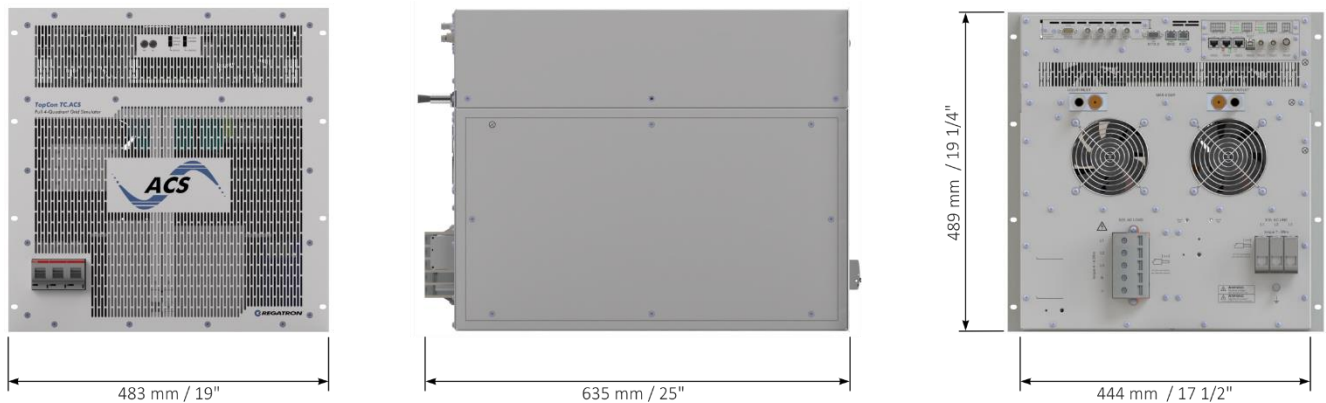

Figure 1: Front, right hand side and rear view. 19-inch module with 11 units in height.

1) Derating of Power depending on the ambient temperature so that the coolant inlet temperature <50 °C.

### Further Description Details

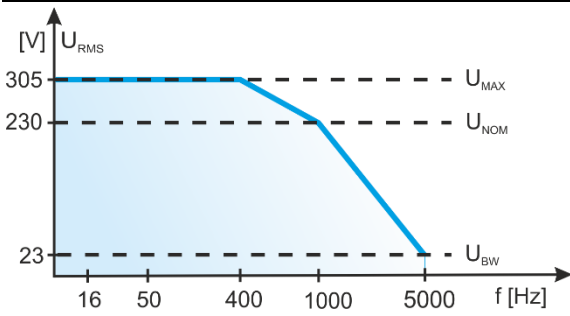

Figure 2: Output voltage versus frequency

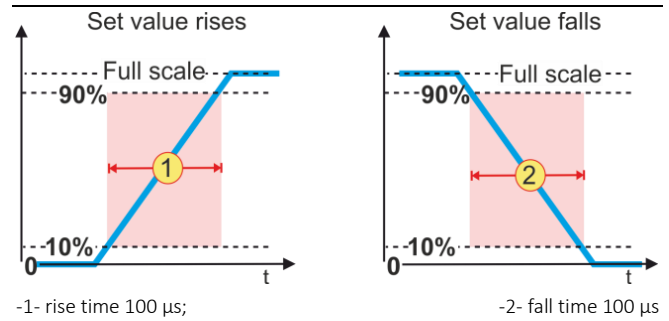

Figure 5: Slew rate with resistive load

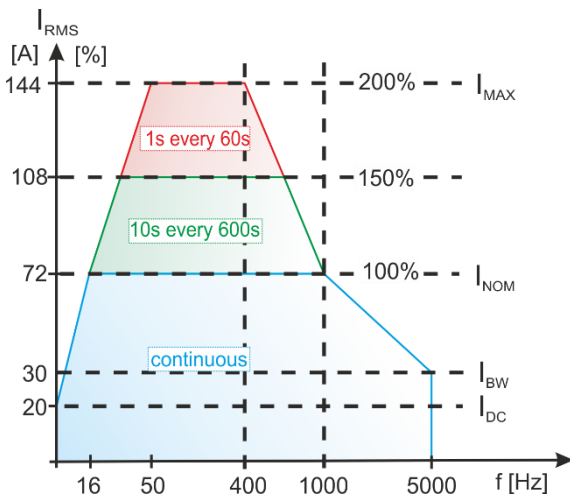
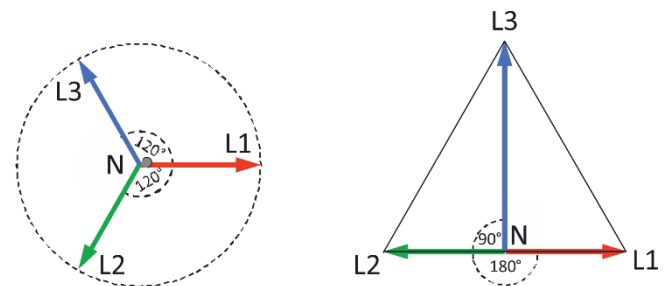

Figure 3: Overloadability versus frequency



any independent phase angle possible, including split phase  
Figure 6: 3L + N

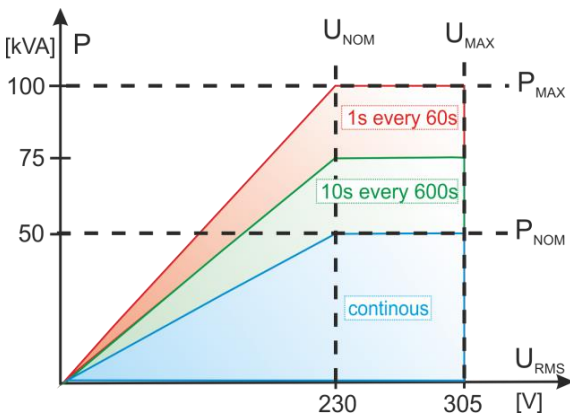

Figure 4: Overloadability versus voltage

This product is developed, produced and tested according to ISO 9001 by REGATRON

For detailed technical information, contact your local sales partner or REGATRON.

Regatron AG Feldmuehlestrasse 50 9400 Rorschach SWITZERLAND sales@regatron.com www.regatron.com	Regatron Inc. 100 Overlook Center, 2 <sup>nd</sup> Floor Princeton, NJ 08540 USA inquiries@us.regatron.com www.us.regatron.com
--	---

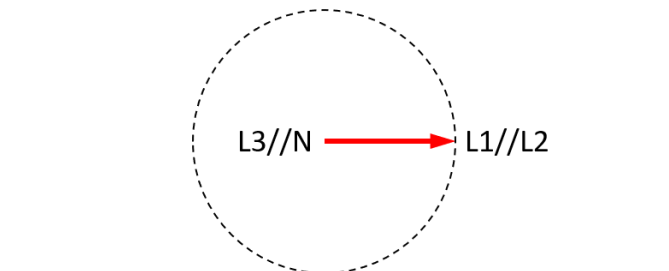

Figure 7: 1L + N (single phase, N related to PE)

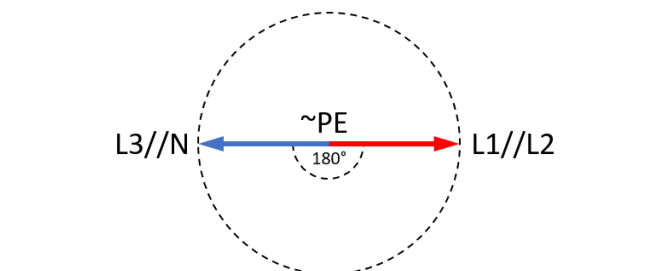

Figure 8: 2L (single phase symmetric to PE)

All product specifications and information contained herein are subject to change without notification.

Filename: DS\_TC.ACS.50.528.4WR.HC.LC\_EN\_221216

Class: Project-specific-use-only